

# ESPERADE



SCENE 86

TAKE 1

BISHOP MANOGUE  
HIGH SCHOOL

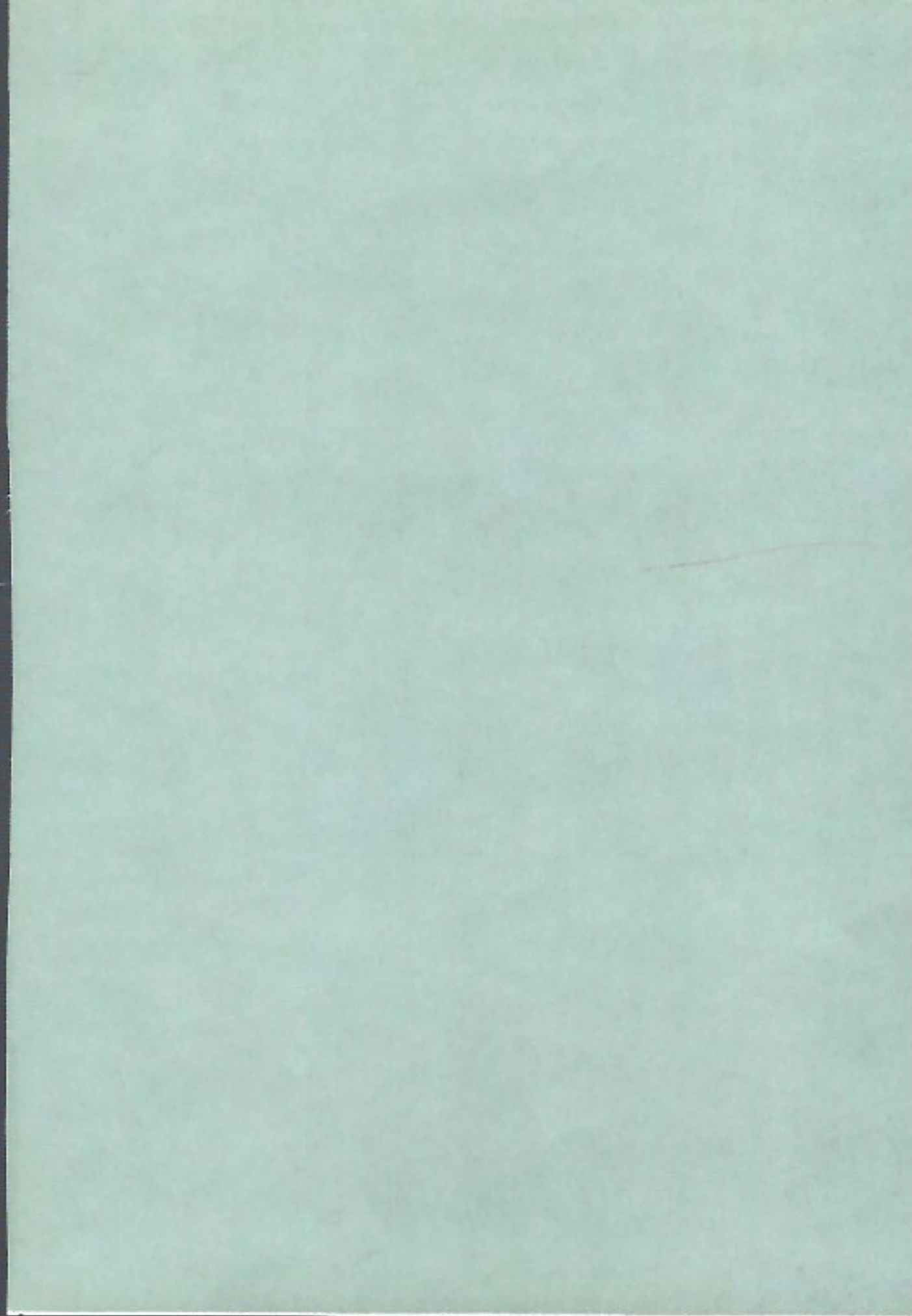



**ESPERADE 1986**  
**BISHOP MANOGUE HIGH SCHOOL**  
**SACRAMENTO, CALIFORNIA**  
**VOLUME XIX**

## THE MYSTERY LADY . . .

Who do the students think is hiding in the bushes between Manogue and AM PM? This famous question arises from the law prohibiting Manogue students from going to AM PM before and after school. Enforcing this law is one of the duties of the Manogue mystery lady. This act, as well as her nicknames, Green Breen, Breeny, and Mean Jo Breen, indicate that there is no fooling around with this lady who is one of the best loved people at Manogue. So, beware of what you do, for she may be watching you!

The personal life of the mystery lady reflects her dedication. Her fondness for blue explains why she hangs around with Manogue girls. Her favorite pastime is going to Vic's Restaurant with Mrs. Haan to eat egg-salad sandwiches and chocolate-moca-almond ice-cream. Martina Valdez points out the mystery lady's potent vitality when she says, "She's a good friend who knows everything. When the lockers were messed up, she fixed every single one." Most of all, the mystery lady treasures caring for "the best girls anywhere."

Who is this lady who beats Sister Bridget Mary to work and is one of the last to leave school each day? From a volunteer in 1973 to a full-time administrative assistant, she has worked with extreme patience and understanding. Mrs. Haan fully agrees: "Clarece gives total 100% support." One may ask, "Why does she work so hard for a small salary?" The reason is that her gentle love for her girls outweighs her desire for money.

The year 1986 is memorable for the mystery lady in that she has had to adjust to the departure of her two good friends, Mrs. Quinn and Mrs. Carroll; however, receiving flowers from students and occasionally receiving special gifts from Margaret Locke, a senior, are special incidents that make her work at Manogue so pleasant.

As you know by now, Mrs. Breen is the "mystery lady" who quietly works behind the scenes without the attention that "superstars" usually receive. She is one special lady, and to show our appreciation, we the students, dedicate the 1986 yearbook to you, Mrs. Breen, for always being there when we need you, and most of all, for being "you." As Bertha Chavez says, "... love that little woman."

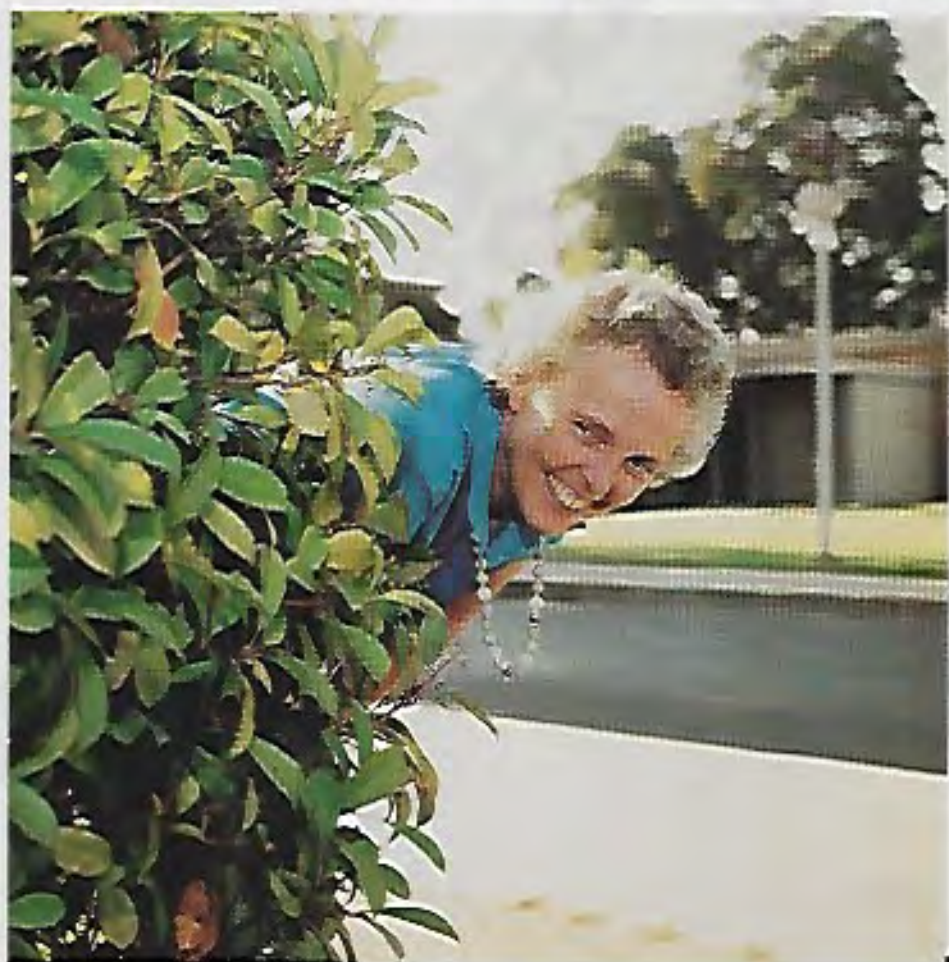

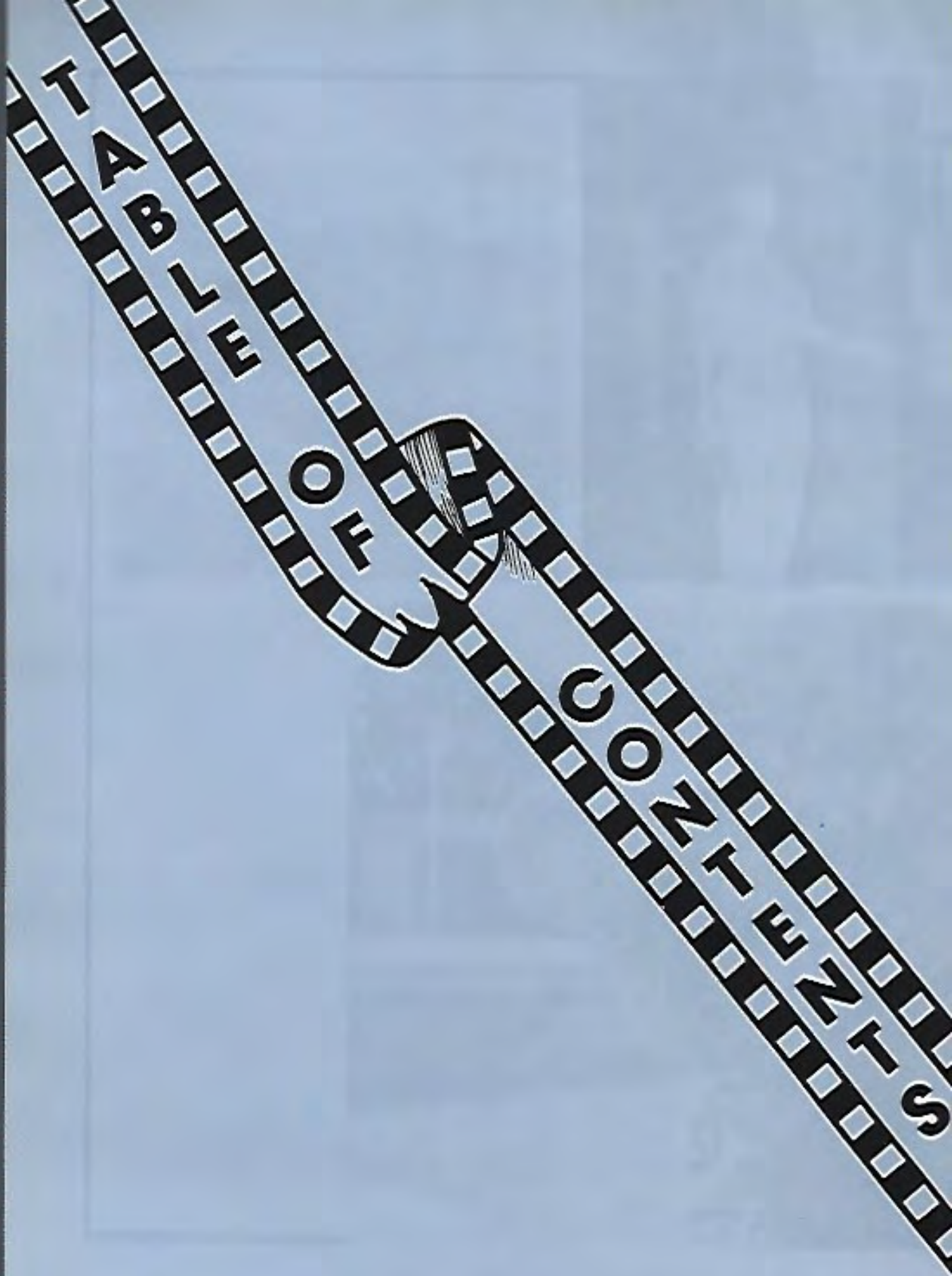

# TABLE OF CONTENTS

<b>DIRECTORS</b>	<b>PAGE 17</b>
<b>ENLIGHTENED STARS</b>	<b>PAGE 29</b>
<b>RADIANT STARS</b>	<b>PAGE 49</b>
<b>RISING STARS</b>	<b>PAGE 61</b>
<b>DAWNING STARS</b>	<b>PAGE 71</b>
<b>SUPERSTARS</b>	<b>PAGE 81</b>
<b>HOLLYWOOD LIFE</b>	<b>PAGE 91</b>



Hey, look us over; we're number one!  
Girls from Manogue High always have more fun.  
We're energetic, industrious, and wise.  
Besides our faith and pride,  
We've got the angels on our side.  
We've got charm, personality, spirit by the pound,  
Cheeriness and friendship, enough to spread around.  
Spelled it's B-I-S-H-O-P-M-A-N-O-G-U-E,  
Bishop Manogue for you and me!





We are the Seniors, the mighty Seniors.  
We will be gone before you know.  
We love you dearly, we mean sincerely.  
We'll make you proud to call us your own.





# THE PRINCE AND THE BISHOP

The Mercy Day Mass celebration began our 1985-1986 school year. The homily, given by Bishop Quinn, conveyed to us, that we as young adults, are capable of making our own decisions concerning the moral values of our community.

Bishop Quinn talked about the rising issue of rating record albums, just as movies are rated. He surprised everyone at the Mercy Day Mass by taking from beneath his vestment the current issue of "Smash Hits" and an article from "Rolling Stone" magazine. In this issue there was an extensive interview with Prince, the first one in many years. The Bishop extolled the virtues of the superstar, who in the public eye, has an outrageous reputation for a wild lifestyle; however it was revealed in the interview that Prince's private life is very quiet and filled with prayer. He is often quoted as thanking the Lord for his good fortune. Although "Purple Rain" is one of the most controversial records in the rating issue, the Bishop still feels it is wrong to deprive today's youth of their individual judgements, the deprivation of which would result in a lack of responsible adults of tomorrow.





# LET'S DANCE



"It was fabulous! There were so many fine guys!" replied Eileen Cubanski. "It was totally bio!" exclaimed Amy Silan and Sara Goehring. "I've never seen so many people! It was great!" said Suzi Gibson. What are all these people talking about? They're talking about Manogue's opening dance, "Let's Dance." It was an inter-school dance with D.J. Michael Thayer. Great music, an extremely amicable atmosphere, and a lot of people made the dance an enormous success! Everyone came out, even the freshmen and guests from other schools. In high spirits, everyone had a great time. It really started the year off with a "bang"!!!







**WE'VE GOT THE TOUCH**







## DIRECTORS AT WORK



# DIRECTORS

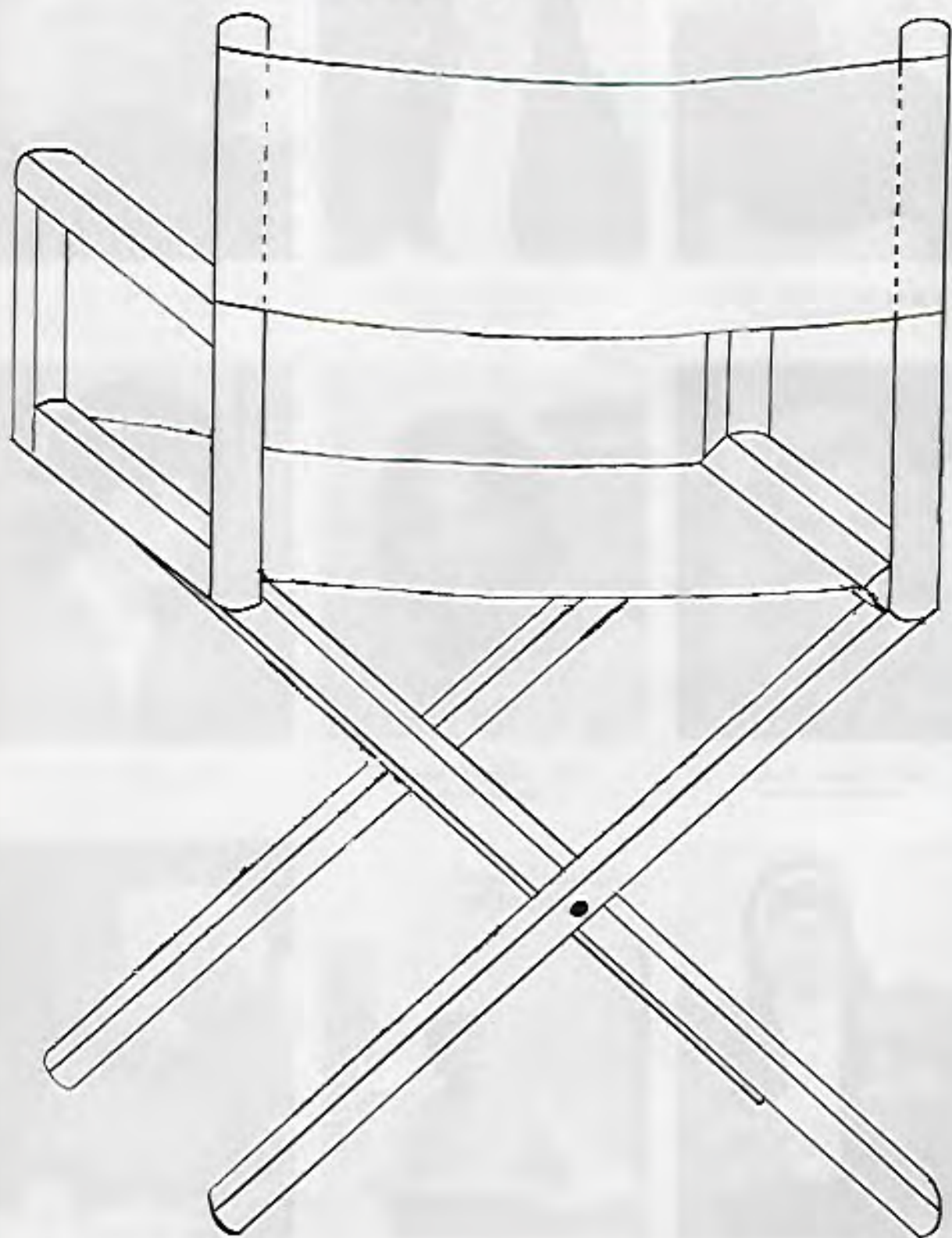



Monsignor Murrough Wallace  
Financial Administrator



Sister Bridget Mary Flynn  
Principal, French



Mrs. Joan Haan  
Vice-Principal, Psychology  
Guidance Chairperson



Mrs. Clarece Breen  
Attendance Office



Mrs. Marie Schmidt  
Bookkeeper



Ms. Nancy Warfield  
Assistant Secretary



Sister Nancy Daniels  
Ann Marie Miller





Mrs. Victoria Alberts  
English, Spanish  
Freshman Class Advisor



Mrs. Diana Bachelor  
Spanish  
Foreign Language Chairperson



Mrs. Carola Blubaugh  
Social Studies, Mock Trial  
Social Studies Chairperson

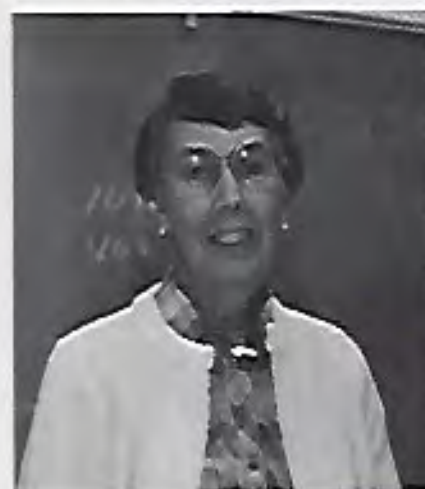

Mrs. Barbara Cagley  
Science, Science Chairperson  
Student Activities Director



Mrs. Chrys Cassetta  
English, Guidance  
CSF/NHS Advisor





Miss Betty Chan  
Business



Mrs. Lois Curtis  
Modern Dance, Dancercise  
Drill Team, Booster Club



Mr. Michael Desmond  
Social Studies  
English, Bookstore



Mrs. Bodil Drucker  
Business, OWE/ROP  
Business Chairperson



Mrs. Jeanette Dyer  
Clothing, Business  
Home Economics Advisor



Mrs. Charlene Eickhoff  
Mathematics  
Detention Supervisor





Mrs. Shelly Hawkeswood  
Guidance

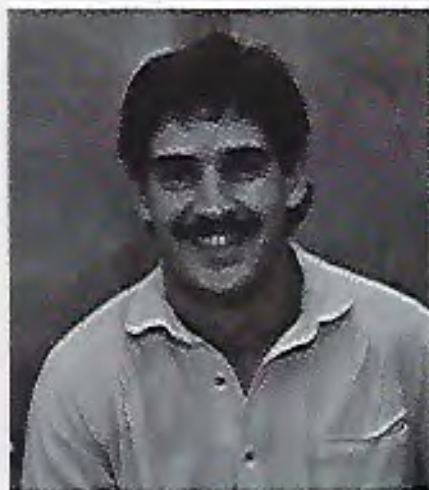

Mr. Stephen Jackson  
Theology  
Campus Minister



Mr. Thomas James  
Mathematics  
Data Processing



Mrs. Judy Kreizenbeck  
Theology



Mrs. Mary Lasken  
Latin, French





Mrs. Norma Lindseth  
English, Child Development  
Ind. Living, Detention



Ms. Wilhelmina Loree  
Guidance



Miss Sharon Luck  
Physical Education  
Physical Education Chairperson  
Athletic Director



Miss Ann Mandalla  
Assistant Drill Team Director



Mrs. Maryvonne Martin  
Art, French  
Fine Arts, Home Ec. Chairperson



Mrs. Barbara Moreno  
Social Studies, English  
Sophomore Class Advisor







Mr. Matt Myres  
Theology, Social Action  
Assistant Campus Minister



Mrs. Debra Pro  
Mathematics  
Mathlete Club



Mrs. Diane Sharp  
Mathematics  
Mathematics Chairperson



Mrs. Cleone Silan  
Librarian



Mrs. Patricia Smith  
English, Drama  
English Chairperson





Sr. Elizabeth Marie  
Guidance



Sr. Joan Marie  
Theology  
Theology Chairperson



Sr. Mary Eileen  
Instrumental Music



Sr. Mary Mercy  
Theology, Latin  
Sacristan



Sr. Maria  
Spanish, Guidance, Maya Club  
Junior Class Advisor



Sr. Mary Michelle  
English, Yearbook  
Eboné & French Clubs





Sr. Nancy Daniels  
Public Relations Director  
Guidance, Publications



Mrs. Connie Sutliff  
Science

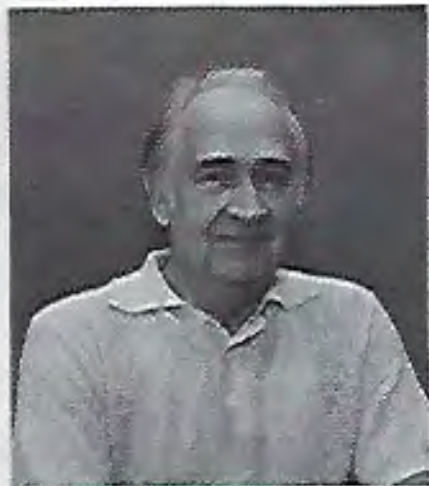

Mr. Robert Taylor  
Science  
Photography Club



Mrs. Fran Trinca  
Health Ed., Guidance  
Senior Class Advisor  
Assistant Stud. Act. Dir.



Miss June Wachter  
General Math., English, Social Studies  
Parent/Student Work Coordinator





Mrs. Toni Pratt



Mrs. Sherley McMahan



Mrs. Louise Medich



Mrs. Karen Teale



Mrs. Jenny Campasano



Mrs. Anne Button



Mr. Antonio Rodriques



Mr. Russel Silva



Mr. Joaquim Vicente



Mr. Augustin Pulido





Tina Valente



Dorene Iiguez



Michelle Carter



Jean Vinson



Ruth Pinchard



Courtney Smith



Lori Mamola



# ENLIGHTENED STARS CAST

<b>DORENE RODRIGUEZ</b>	<b>PRESIDENT</b>
<b>JEAN VINSON</b>	<b>VICE-PRESIDENT</b>
<b>CAROLYN SILAN</b>	<b>SECRETARY</b>
<b>MICHELLE FANNER</b>	<b>TREASURER</b>
<b>LORI MAMOLA</b>	<b>GUMBY</b>
<b>JANINE GIBFORD</b>	<b>SENATOR</b>
<b>RUTH PLANCHARD</b>	<b>SENATOR</b>
<b>COURTNEY SMITH</b>	<b>SENATOR</b>
<b>TINA VALENTE</b>	<b>SENATOR</b>

**UD-86**



**Lisa Marie Aguilera**  
 Different eyes see different things; Different hearts beat on different strings. Rush. Mom, thanks for being there



**Martha Lorena Baeza**  
 I find the great thing in this world is not so much where we stand as in what direction we are moving. Holmes



**Jo Ann V. Baluyut**  
 United we stand, divided we fall. A.E.S. Thanks mom and dad - Where's my Me



**Elena Sue Biundo**  
 Cherish every moment we have been given, for time is passing by. KATG



**Stacie Lenore Bolden**  
 If you believe, look to the dawn and you shall never lose. I love you, mom! Prince Roger Nelson



**Janice Lee Busch**  
 Help me make the most of freedom the pleasure; nothing ever lasts forever. Tears For Fears





**Angela Marie Buxie**

To live our life to the fullest and to be the best we can be is all we can ask. PS - Thanks mom and dad!! Love AMB



**Heather Ann Cardoza**

If there's anything I can do, just call on me, and I'll send it along with love from me to you! The Beatles ILYMD U2SAP



**Michelle L. Castillo**

A dream is a wish your heart makes when you're fast asleep! Electric Dreams Thanks mum&dad Cheerio! AussieBrit!



**Marcella Cathcart**

The world is a comedy to those who feel and a tragedy to those who think. Shakespeare



**Deann Rose Cervantes**

See what love the father has bestowed on us in letting us be called children of God! John. Thanks mom and dad. I love you



**Charlene Cheung**

Two people that I love in this world are Mammy & Daddy. Thanks for my brother & Joyce & BMH



**Anna Maria Estella Christensen**  
I don't care what people say - nothing is perfect anyway. No one said the world was fair; all I want is for you to care.



**Tenishia Cummings**  
I live, my Trinity God, so live in me, that all I do be done by you; all I think and all I say be your thoughts and words today.



**Justina Davis**  
Don't try to live your life in one day. Don't go speed your time away.  
Howard J.



**Lisa Yvette DeBlasio**  
Each of us is here for a brief sojourn; for what purpose he knows not, though he senses it.  
Albert Einstein



**Naomi DeLeon**  
I made it through the wilderness. Somehow I made it through.  
Madonna



**Suzanne Katherine Delisle**  
Here's to good friends; this year was special... Thanks! "Later, I'm outta here."  
Bo Brady "D"



**Kelli Deuson**

Let sadness see what happy does - Let happy be where sadness was. Jackson 5 "Mom, Thanks! I love you! KED



**Diane Lynne Duncanson**

Live life and love who you are 'cause all of us were born to go far! Kool & the Gang - I love you tons, Mom & Dad.



**Celeste Christine Elder**

God is love, and whoever lives in love lives in God, Deus est amor, et quisquam in amore vivit in Deo vivit. I John 4:8



**Jacqueline A. Escajeda**

No bird soars too high if he soars with his own wings.

II YMDJMMGB



**Tressy Pauline Espinoza**

The time has come when we have to part, but the memories we've gained will stay forever.

Luv you, P.U.



**Michelle Eileen Fanner**

I have a dream that one day I shall attain heights unknown by others.

I love you, Grandmother.



**Carolyn Anne Fletcher**

Make the most of what you can, with what you have and where you are. Be your best cuz life's too short! I Luv U mom CBEARS



**Sylvia Veronica Franco**

A rose is exactly the way I feel, as the friendship between you and I. Except for one important fact, a rose can die. GMF



**Lynly M. Gant**

I dream and I explore. Life is my faith; is my dawn. Love life, and search for truth with faith and God. B.Z.



**Debbie Jean Garcia**

It's hard to say goodbye knowing we may never meet again. Good luck '86. I Love You All. -Future DJG m.d.



**Pamela Anne Gesdahl**

Cherish your friends because they are like a bridge over troubled water. I Love You All! Esp. my best friend - mom



**Janine Renee Gibford**

If love never lasts forever, tell me, w forever for?

ILYMDJ&GAR



**Sara Marie Goehring**

We all start out pretty much the same, but where you go from there is entirely up to you! Thanks to Amy, Mrs. C, & Cathy



**Cynthia Rae Gonzales**

Music is the way memories sing to us across time.

Lance Morrow



**Christy Green**

I'm as free as a bird now, and this bird you cannot tame.

Lynyrd Skynrd



**Karen Denise Gums**

First give an honor to God and to my mom. I just want to thank you both for everything. Love Always Karen D. Gums



**Stacie Paige Hansen**

I was searching for something profound, but, shucks folks, I'm speechless!!

-Vida



**Kimberly Marie Harris**

I know it hurts to say goodbye, but it's time for me to fly. I love you, Mom and Dad REO Speedwagon



**Susie Hernandez**

Dejad el futuro detener los suenos del mañana, y el pasado las memorias de ayer. Thank you Mom and Dad, God bless.



**Maria Hernandez**

Hey you! Out there beyond the wall. Hey you! Don't tell me there's no hope at all. Together we stand, divided we fall.



**Myrna Hernandez V.**

In order to get from what was to what v be, you must go through what is. Gracias por su amor Padres y Grandma.



**Sonia Hernandez**

To: The Class of '86. You are all very special to me. I'll miss you. Special love and thanks to my Mom and David.



**Kristine Lynn Huddy**

Love is open arms. If you close your arms to love, you'll find you're left holding only yourself. I love you Mom and Dad!



**Jackie M. Johnson**

So long, and thanks for all the fish-Douglas Adams



**Karen Arlene Jones**

How high I aim, how much I see, how far I reach depends on me! I love you always Mom and Dad. KAJ



**Amanda Marie Kearney**

Why does the more reasonable way always seem to be the wrong way! with love and thanks to Mom and Dad!



**Rachel Ann King**

You look mahvelous and I don't say that to everyone darling! Billy Crystal as Fernando



**Lisel Susan Kupelian**

When I leave I don't know what I'm hoping to find, and when I leave I don't know what I'm leaving behind. Rush



**Rachel Tiffany Lewis**

Tired is a luxury of the rich. Pause if you must, but do not quit. My Grandfather De-mar Lewis I (1896-1973)



**Margaret Locke**

If your heart is full of love, you will always have something to give. Thanks Mom and Dad for all you've given me.



**Aurelia Lopez**

It doesn't matter who you are .....  
What's in your heart will never change ....  
What's in your heart will always stay the same.



**Rachel Lopez**

How do u thank someone who's taken u  
from crayons to perfume; it isn't easy but  
I'll try Thank Dad and Mom



**Donna Elaine Lovejoy**

Life's happiest times are remembered  
back on the good times shared w  
friends. C.M.P. P.S. I Luv You, Mom &  
Boo-Boo



**MaryAnn Maldonado**

No joy can compare to the joy of graduat-  
ing and getting out of this school! Thanks  
Mom and Dad.



**Lori Terese Mamola**

Grad Night 86- I can feel it coming in the  
air tonight - I've been waiting for this mo-  
ment for all my life. Phil Collins



**Ana Maria Martin**

Destiny isn't a matter of choice; 'tis no  
thing to be waited for, 'tis a thing to  
achieved.





**Melissa Martinez**  
Take your souls and your goals to the top.  
Quiet Riot - Thank You Dad & Mom - Love  
YAI MEL



**Dawnyel McCarty**  
Come explore your dreams' creation Enter  
this world of imagination. -Rush 2112



**Margarita Mendoza**  
Lo mejor del futuro es vivir un día a la vez  
Gracias por todo papa y mama - los quiero  
mucho su hija Mague "86"



**Omeedeh E. Minoui**  
... but it's the laughter we shall remember  
whenever we remember the way we were.  
Streisand. I luv you mom thanks!



**Maria Montañez**  
Gracias a Dios porque ahora me siento  
libre. mami, te quiero! M&M



**Lora Lee S. Nebreda**  
Never before have we had so little time in  
which to do so much. -FDR Love You  
Mom and Dad! "86"



**Lechi Thi Nguyen**  
The main thing in life is not to be afraid to be human. Pablo Casals Su Han Hanh cua Toi La Nguoi Viet



**Maria J. Oropeza**  
"Bees without stingers are dead ones; think about it!" S.R.T. June 6, 1985



**Claudia Dolores Ortega**  
"Blinded some are of what could be, missing the beauty that others will see." May God tenderly watch over you mom. CL



**Kimberly Ann Palacios**  
For your love and faith in me that never went astray, I dedicate my love to you each and every day. Thank mom I love you!



**Colleen Michele Parise**  
Ain't it funny how time flies when the best is yet to come. Bryan Adams



**Stephanie Marie Padone**  
Be not afraid of life. Believe that life worth living and your belief will help create the fact." William James



**Renise Monica Perez**

We never know the love of our parents until we have become parents ourselves. Thanks Mom. I luv u a lot. Monica



**Beth Ann Pfister**

It doesn't matter who you are, its what you do that takes you far! Madonna I made it! Love you mom and dad. BAP DJ



**Ruthie Planchard**

My love for you knows no boundaries. It comes with the sun but does not leave with it. Thanks mom and dad Love Rufus



**Nancy Quackenbush**

Love isn't what makes the world go round it's what makes it all worth while. Thanks for the love ... Mom and Dad



**Michele Renee Ramirez**

"The tender leaves of hope; tomorrow blossoms. Shakespeare. I finally made it! Luv u always mom & dad



**Erika Felitia Rawlins**

The best gift you can give is the sound of laughter and the memory of a smile. - M. Locke - Thanks Mom and Dad



**Louisa Renteria**

There is no art to find the mind's construction in the face.

Shakespeare in *Macbeth*



**Dorene Denise Rodriguez**

The man who says, "it can't be done," is liable to be interrupted by someone doing it. Thanks Mom!!!



**Hillary Anne Rogness**

God grant me the courage to change things I can, accept things I can't, and wisdom to know the difference.



**Aida Maria Rosa**

I've been waiting for this moment for all my life. Phil Collins  
Thanks Mom and Dad



**Anna Maria Rubalcaba**

Just believe and your dreams will come true; it's a fact that it's all up to you. ILYM-DAM



**Mary Saalsaa**

Nothing ever lasts forever - but the special moments and memories will always remain! I luv u Moms & Pops! Mary Mo...



**Yolanda Sanchez**

Follow your dreams wherever they may lead and look forward with confidence and back without regrets. Gracias nama Y Papa



**Kristina Schubert**

Faith is the bird that feels the light and sings while the dawn is still dark.

Tagore



**Carolyn Jean Silan**

Every experience elevates you to a new level of understanding. -CJS Thanks to all Luv ya M.B.B.'s



**Maria Eugenia Silva**

"Vive cada dia a pleni tud, obtiene lo mas de cada hora, dia, y edad de tu vida" Gracias por todo Papa Y Mama Genia



**Courtney Dianne Smith**

Life is like a rose; it has soft petals and sharp thorns. - You have to accept both.



**Judy Marie Talani**

When your heart is full of love. You always have something special to give ... Thanks 4 the memories, I luv u all! Puff



**Keeley Thompkins**

Mama may have ... Papa may have ...  
God Bless the child that's got his own. I  
Love you Mom! Billie Holiday



**Dena Monet Trevino**

I'll reach out my hand to you; just have  
faith in all I do. Where there is love, I'll be  
there. M. JACKSON ILYMD TE AMO JV



**Susan Rose Turner**

Meeting again after moments or lifetimes  
is certain for those who are friends ...  
SMILE! I love you, Mom and Dad!



**Jennifer Valdivia**

Whatever I look for I'll find and whatever I  
hold within myself I'll become. Thanks  
Mom & Dad. I love you both!



**Tina Marie Valente**

Now as the sun rises, I find a new day; I  
have seen the best of both worlds, I wish I  
could stay. KNIGHT



**Adina Velasquez**

Now it's time to say good-bye to the one  
we love, but always remember the mem-  
ories will last forever! AMV



**Jean Marie Vinson**

You are never given a wish without also being given the power to make it true. R. Bach



**Hanh My Vu**

To Mom and Dad: Thanks for all of your support! I will always need you. Class of '86"



**Julianne Walery**

The more I look at the life that's ahead of me, the more I want to spend it with you. I love you Mommy and Daddy!



**Tracey Mary Ward**

Gosh, I just hate it when this happens. Good-bye to all my friends. I love you all Willie and Frankie SNL-Beaker



**Darla Weaver**

Know from whence you come. If you know whence you came, there is really no limit to where you can go. James Baldwin



**Debbie Lynne Weber**

The message is perfectly simple; the meaning is clear. Don't ever stray too far ... don't disappear. ABC



**Monica Raye Wooten**

I have to go for what I want ... pray ... and make it all happen!!! MRW Thanks mommy and daddy ... I Love You!



**Tracy A. Yates**

My parents didn't tell me how to live; they lived and let me watch them do it. Ma, Pa, Den; thanx! Luv ya lots!

When I consider my four years here,  
 It's not without remembering  
 The laughter, fun and tears,  
 The friends I've made,  
 The times we've shared together,  
 And the precious memories  
 That I will cherish in my heart  
 Forever.

It's like I've found a four-leaf clover  
 So unique and rare,  
 Like the love and unity of our school  
 To which no other can compare.  
 Each petal represents our high school years  
 Filled with adventures to explore,  
 Dreams to pursue,  
 Trials and tribulations,  
 Celebrations,  
 Always seeking something new.  
 So naive were we our freshman year,  
 Seeking courage and acceptance  
 From new friends and peers.  
 But confident and brave our sophomore year,  
 Seeking independence for ourselves,  
 Leaving behind our adolescent fears.  
 Scarce did we know



What junior year held in store;  
 We prayed for strength not to fall  
 When the "going got tough."  
 Now as petals become scarce  
 And we approach the end of senior year,  
 We seek guidance and prayers,  
 And God's presence always near.  
 As we plan for our future  
 And work toward our dreams,  
 May we carry with us our four-leaf clover,  
 Because to each of us it brings  
 The sound of familiar laughter  
 And the smiles of special friends  
 That, unfortunately, we may never meet again  
 Yet we will always cherish these memories  
 In our hearts,  
 And therefore, you and I  
 Will never really part.  
 So as I clasp my four-leaf clover  
 To the Class of '86,  
 I salute you!  
 Wishing you luck wherever you may be,  
 And hoping that we keep our spirit  
 Alive for all  
 Eternity.

-Nancy Quackenbush







SH  
E  
A  
A  
A  
A  
A  
A



Sandra Jauregui



Anaïshea de Guzman



Laura Goodrich



Lillian George



Valerie Febre



Tom Black



Candy Collins



Becky Corona



Sheree Page

# RADIANT STARS

## CAST

LAURA GOODRICH	PRESIDENT
BECKY CORONA	VICE-PRESIDENT
VALERIE FEBRE	SECRETARY
SHEREE PAGE	TREASURER
LILLIAN LEONG	SMURFETTE
TINA BLACK	SENATOR
CANDY COLLINS	SENATOR
ANA-RHEA DE GUZMAN	SENATOR
SANDRA JAUREGUI	SENATOR

UD-87

Mary Aguilar  
Veronica Alcazar  
Tresa Archuleta



Sorry  
No Photo

Beatriz Avalos



Sheelah Becknell



Serena Benito  
Tina Black  
Robyn Brown



Julie Brusato  
Catherine Butler  
Christine Capogreco





Sorry  
No Photo



Delena Castillo  
Antoinette Carmona  
Bertha Chavez



Maya Christensen  
Candy Collins  
Lori Colson



Lynda Contreras



Cheryl Cook



Rebecca Corona  
Teresa Correa  
Jennifer Council

Fileen Cubanski  
Ana-Rhea De Guzman  
Richelle Deremo



Sunni Esparza



Valerie Febre  
Rebecca Fielder  
Lillian Fua



Melissa Gallegos  
Gayla Garcia  
Irene Garcia



Yvonne Garcia





Grace Goff



Laura Goodrich  
Leila Gomez  
Cindy Gutierrez



Kenna Hamilton  
Michelle Haggood  
Jennifer Hernandez



Lisa Hernandez



Melinda Hernandez  
Veronica Hernandez

Elizabeth Janson  
Sandra Jauregui  
Yvonne Jennings



Jennifer Johnson  
Lynne Kaiser  
Monique Kenoly



Kimberly Korhonen  
Joni Lara  
Laura Ledesma



Lillian Leong



Lisa Linares







Erinn Lopez  
 Tammy Lovato  
 Mai Luong



Seleste Madrid  
 Joanne Manzo  
 Suzanne Mc Kelvey



Christine Mc Rae  
 Lisa Mejia  
 Dolores Mermejo



Laurie Miller



Gina Mosqueda

Vanessa Murry  
Olga Navarrete  
Hanh Nguyen



Holli Nguyen



Debbie Norton  
(No Picture) Sheree Page  
Virginia Pennington  
Tammy Perez



(No Picture) Allonette Peterson  
Tisha Phillips



(No Picture) Maria Pires  
Araceli Reyes





Angela Rice  
Ana Rios  
Angie Rodriguez



Rachel Rodriguez



Renee Rodriguez



Sharon Rodriguez  
Teresa Rodriguez  
Carmen Roldan



Monica Roma  
Sophia Romo

Lisa Sandborn  
Laura Schield



Gina Seidel  
Sharmie Silva



Jenny Sontag  
Marian Stovall  
Lisa Styler  
Stacy Sukauskas



Lorraine Taylor  
Verlene Thom





Stefanie Tully  
Martina Valdez



Julie Valencia  
Rebecca Vega



Cristi Vellanowes  
Kathleen Vessels  
Isabel Vicente  
Teresa von Phul



Phuong Vu  
Daneen Wicks





Cindy Giordano



Anne Trinca



Melissa Mayorga



Aracely Jauregui



Shelly Del Dato



Heidi Worm



Sharon Castillo



Marisela Haro

# RISING STARS

## CAST

SHELLY DEL DOTTO	PRESIDENT
SHARON CASTILLO	VICE-PRESIDENT
MARISELA HARO	SECRETARY
MELISSA MAYORGA	TREASURER
HEIDI WORM	ODIE
CINDY GIORDANO	SENATOR
ARACELY JAUREGUI	SENATOR
AMY SILAN	SENATOR
ANNE TRINCA	SENATOR

**LD-88**

Deana Abeyta  
Cynthia Armenta  
Genice Arnold  
Eve Azeltine



Dawn Baker



Karina Basurto



Kerrie Bathel



Cynthia Bejarano



Kelley Bloom  
Toni Cammarano  
Gloria Cardoza  
Ann Caruso







Michelle Castellano  
Lorena Castellanos  
Sharon Castillo  
Alicia Chavez



Christa Conrado



Juliette Cubanski



Kellie Curtis



Christy Davis



Photo Not  
Available



Joanie Davis  
Michelle DelDotto  
Paulina De Leon  
Shelia Duruisseau

Christine Enos  
 Estela Esquivel  
 Ana-Leslie Fernandez  
 Shelly Fruchtenicht



Anita Garcia



Martha Garcia



Marcela Garcia



Cindy Giordano



Melissa Hagemann  
 Marisela Haro  
 Jeanie Hernandez  
 Xochitl Hernandez



NO PHOTO  
AVAILABLE



88

Rebecca Hershberger  
Cynthia Jasso  
Aracely Jauregui



Marilyn Klopp



Monica Ledbetter



Renee Ledesma



Molly Lipelt



Christine Lopez  
Tara Lowas  
Virginia Macias  
Rebecca Madrigal

Lydia Manriquez  
Kathy Martinez  
Marina Martinez  
Tracy Martinez



Melissa Mayorga



Shani Mc Cray



Renea Mc Ghee



Stacy Mitchell



Martha Molina  
Nichelle Moreno  
Jana Morris  
Beatriz Navarrete





Photo Not Available

Deborah Nevarez  
Nicole Peake  
Veronica Perez  
Yolanda Perez



Amber Pertl



Haydee Pineda



Maria Ramirez  
Michelle Ramos



Paula Reginato  
Maria Requejo



Kelli Sale  
Lisa Saucedo  
Wendy Semon

Dina Sequeira  
Amy Silan  
Tiffany Solorio  
Kerith Starkes



Yolande Thompson  
Georgie Tolle  
Doris Tormes



Jennine Tran  
Theresa Tran  
Lynette Trevino



Anne Marie Trinca



Lisa Trn





Michelle Valdez  
Margaret Veldman  
Neshka Virdure  
Rayann Von Schoech



Tes Warwick  
Laura White  
Leslie Whitlow



Sandra Wong  
Heidi Worm  
Diana Yanez



Meg Wolfe



Becky Young





MABRIELLE CAMMARANO, THERESA PEREZ  
LAURIE PERRY, DEBRA GONZALES,  
AND SALINA GARCIA



LISA NEVES



CATHERINE CARDA AND MARY



JOSEFINA VELLANOWETH AND VANESSA DE LEON



# DAWNING STARS CAST

MELBA ABERO

PRESIDENT

CATHERINE CARDA

VICE-PRESIDENT

VANESSA DE LEON

SECRETARY

ROSELENA VELLANOWETH

TREASURER

LISA NEVES

ODIE

GABRIELLE CAMMARANO

SENATOR

SALINA GARCIA

SENATOR

DEBRA GONZALES

SENATOR

THERESA PEREZ

SENATOR

LAURIE PERRY

SENATOR

LD-89

Jeanne Abaya  
Melba Abero  
Kim Ablog  
Lisa Adame



Sylvia Aguilar  
Tillie Aguilera  
Rosanne Aguirre  
Jennifer Albert



Cristina Alcalá



Kristel Bellby



Lourdes Benitez



Jennifer Beno  
Kindra Berdan  
Dennette Bristol  
Sundae Brooks



Photo Not Available



Lorna Marie Butts  
 Gabrielle Cammarano  
 Catherine Carda  
 Catherine Carroll



Monica Casillas  
 Christine Castellano  
 Kathryn Caudillo  
 Karin Ceaglio



Lisa Cedros



Dena Cervantes



Lucy Chavarria



Sonja Chavez  
 Tamara Chavez  
 Marlene Contreras  
 Camille Correa

Cynthia Davis  
Debra De Journett  
Vanessa De Leon  
Regina Diaz



Yvette Dominguez  
Kathy Dunsmore  
Laura Fhret  
Melissa Fajerson



Photo Not  
Available



Laura Fernandes  
Pamela Fratis  
Salina Garcia



Elizabeth Gibou  
Suzanne Gibson  
Dawn Goff  
Debra Gonzales





Photo Not Available



Valencia Hale  
Cathy Hamilton  
Carrie Hanson  
Sydney Harleaux



Ericka Harris  
Sara Hernandez  
Ivonne Herrera



Michelle Hollman  
Tiffany Hunter  
Pamela Johnson  
Monica Kelly



Photo Not Available



Valerie Kokilananda  
Jill Kupelian  
Lisa Lippincott

Veronica Lopez  
Marina Lovato  
Rebecca Lopez  
Jolynn Macias



Eden Mannion  
Stefanie Martinez  
Stephanie Mc Kenzie  
Abygail Medina



Michelle Mermejo



Photo Not Available

Mary Moore



Ann Marie Moreno



Lucille Moreno  
Sandra Moreno  
Roxanne Munoz  
Samira Nassar





Lisa Neves  
Hang Nguyen  
Juanita Ortiz  
Guadalupe Peregrina



Theresa Perez  
Laurie Perry  
Jeanette Peterson  
Janine Pomaes



Christina Porter



Elizabeth Ramirez



Yolanda Ramirez



Angelica Reyes  
Christina Rodriguez  
Michelle Rodriguez  
Isela Saavedra

Regina Sams  
 Cecilia Sanchez  
 Rosalie Santander  
 Mia Santoscoy-Dougherty



Amy Schneider  
 Doris Sevilla  
 Liza Solis  
 Lori Solis



Tracy Soto  
 Tammy Teal  
 Christine Torio  
 Lisa Torres



Kim Touneh  
 Cecile Tran  
 Jennifer Trier







Debra Tully  
Angela Umali  
Elizabeth Valdez



Theresa Valdez  
Katrina Valente  
Dina Vasquez-Tennison



Roselena Vellanoweth  
Jenny Vine  
Vandha Vingan  
Sara Vinson



Andrea Weathers  
Minka Weaver  
Melissa White  
Christine Wilfong

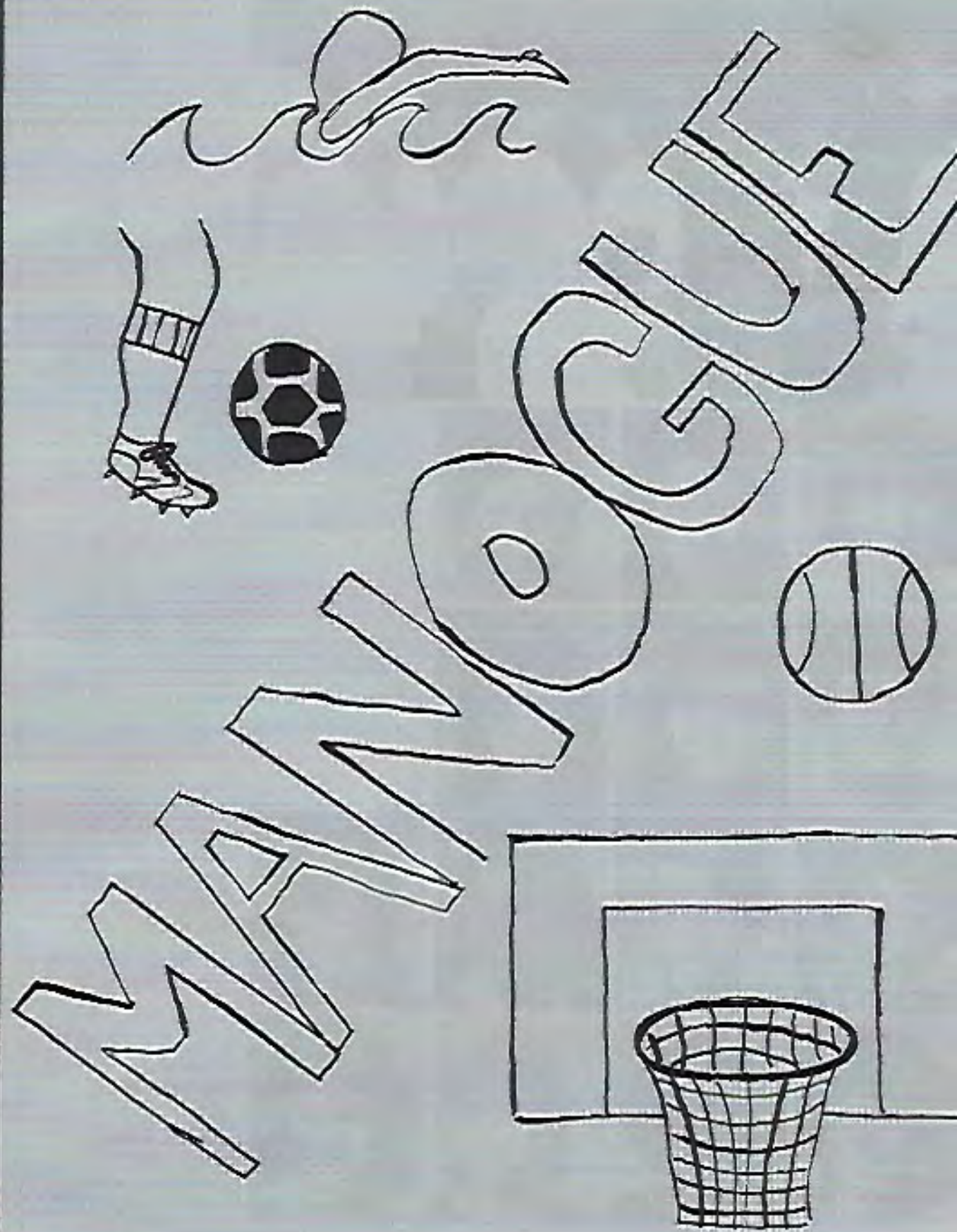



# WAY TO GO, MANOGUE



First row from left to right: Laura Goodrich, Beatriz Avalos, Bernd Chavez. Second row: Coach David Dacong, Eileen Cubanski, Le Mamola, Wendy Semon, Ana-Rhea de Guzman, Mary Aguilar. Third row: Colleen Parise, Hena Blundo, Tina Davis. Top: Janice Busch.



**VARSITY RECORD**  
**FIRST HALF OF SEASON**

<u>MANOQUE</u>	<u>OPPONENT</u>
WON	COUNTRY DAY
WON	RIVER CITY
LOST	JOHNSON
WON	MCCLATCHY
WON	BURBANK
LOST	SACRAMENTO
LOST	ST. FRANCIS
WON	KENNEDY
WON	CORDOVA

**SECOND HALF OF SEASON**

LOST	JOHNSON
WON	MCCLATCHY
WON	BURBANK
WON	SACRAMENTO
WON	ST. FRANCIS
WON	KENNEDY
LOST	CORDOVA



Placing third in the Metro League, Manogue's Varsity Volleyball Team met with victory in Practices, which began during early September, allowed the team to better prepare for the excellent showing.

When asked about the team's performance, Ana-Rhea Guzman exclaimed, "I thought the year was sensational! I wanted to get to the playoffs and we did! We lost, (the playoff game) but we didn't lose without a fight!"

"We are the best! We are invincible!" boasted Lori Mamola.

Highlighting the season was the home game against the school St. Francis. With the gym tropically decorated to the theme "Go Hawaiian", the fans got into the spirit by wearing Bermuda shorts and bright floral shirts. Leading an incredible triumph over the St. Francis Troubadours, the Mustangs concluded the match 15-9, 14, and 15-11.

Tina Davis, a senior honoree summarized the season, "It was energetic! We had our fun but working together as a team was a victory in itself!"

Three seniors were selected to the 1985 All-Metro Team. Congratulations to:

- Elena Biundo
- Lori Mamola
- Colleen Parise

# FRESH TALENT

New faces on the court, nine freshmen and two sophomores constituted the 1985 Frosh-Soph Volleyball Team. These troopers, led by first year coach, Chris Carmazzi, battled through one tough season all right. With their record 1-14, many of the players felt discouraged. Laura Fernandes stated, "It was fun, but our attitude as a team wasn't at its full potential."

When questioned about the season as a whole, sophomore Becky Hershberger humorously replied, "It was a lot of fun, even though I got some major bruises."

Although the season was not as successful as was hoped, the team must be commended for its valiant efforts. Having a whole season of high school volleyball behind them, next year's team will surely be a noble challenger in the Metro League. As enthusiastic Haydee Pineda put it, "Although our volleyball season wasn't as we had expected it to be, we still had a full season of fun and friendship. I am confident that next season will be full of more fun, friendship, and VICTORIES!"

A pat on the back goes to Karin Ceaglio, who was selected to be on the 1985 All-Metro Team! Great job, Karin!



Top row from left to right:  
Karin Ceaglio  
Haydee Pineda  
Toni Cammerano  
Theresa Perez  
Alicia Chavez  
Middle row:  
Laura Fernandes  
Coach Chris Carmazzi  
Gabbie Cammerano  
Bottom row:  
Aby Medina  
Cathy Carda



# MANOGUE CHARGES THE NET



Getting off to an eager start, this year's tennis team met with opposition. Under the direction of Coach Angela Schmidt, who played for CSUS, Manogue spent all season preparing for the Metro League Competitions.

Manogue's spirit really shone through the stamina, determination, and unity of all the players during the season.

The tennis team includes: Melissa Martinez, Sundae Brooks, Pam Fratis, Eve Azeltine, Christine Torio, Regina Sams, and Lisa Trn. We would like to thank the tennis team for giving it their all this year!



Top row: Melissa Martinez, Sundae Brooks, Pam Fratis, and Eve Azeltine. Bottom row: Christine Torio, Coach Angela Schmidt, and Regina Sams.

# M A N O G U E B A S K E T B A L L



Varsity: Roxanne Munoz, Lisa Lippencott, Joanie Davis, Sheila Durrusseau, Dawn Goff, Sundae Brooks, Christine Wilfong, Roseanne Aguirre, Samira Nassar, Coach Al Brown, Rebecca Fielder, Leslie Whiflow, Kellie Curtis



Fresh-Soph: Salina Garcis, Icanette Peterson, Lorna Butts, Kim Ablog, Becky Hershberger, Pam Johnson, Mary Moore, Stephanie McKenzie, Sonja Chavez, Becky Madrigal, Sydney Harleaux, Coach Dan Munoz, Sandra Moreno





# MY HEART BELONGS TO DADDY

The annual Father/Daughter Dinner Dance was held on January 24, 1986. This dance was presented by the Bishop Manogue Parents Club. The theme for this year's event was "My Heart Belongs to Daddy". The dance was really a lot of fun. Our guests first started off by seating themselves and getting acquainted with the other guests at their table. Then the dinner was served. The dinner included a choice of roast beef with gravy or a slice of turkey with gravy. This also included a choice of mashed potatoes or rice. We also had something new this year, a salad bar. This gave everyone a chance to fix their own salad. After the dinner, we started off the dancing with the traditional Father/Daughter March. The Music this year was by Micheal Thayer Productions. A special thanks to our chairpersons:

General Chairpersons . . . . Ray and Cora  
Martinez  
Co-Chairperson . . . . . Bertha Bejarano  
Dinner Tickets . . . . . Carol Teal  
Decorations . . . . . Committee  
Name Tags . . . . . Pat Busch  
Servers . . . . . Francisca Requejo  
Raffle . . . . . Gui Sequeria  
Beverages . . . . . Bertha Bejarano  
Finance . . . . . Dan Shield  
Publicity . . . . . Irene Martinez  
Table Set-Up . . . . Mr. & Mrs. Jose Lopez  
Coat Room . . . . . Marina Rodriguez  
Corsages . . . . . Alumnae Association





My life began  
and he was there.  
Throughout the years  
of broken bikes  
and toothless smiles,  
he was there.  
Time passed  
and phones rang  
and boyfriends came,  
Yet with a smile,  
he was always there,  
Tears were shed  
and laughter was shared  
as memories were made,  
and he was there.  
Now as I look back  
in love and admiration,  
I know he was always  
there for me,  
and always will be.  
Is there any wonder why  
my heart belongs to Daddy?



FATHER/DAUGHTER DINNER



HOLLYWOOD

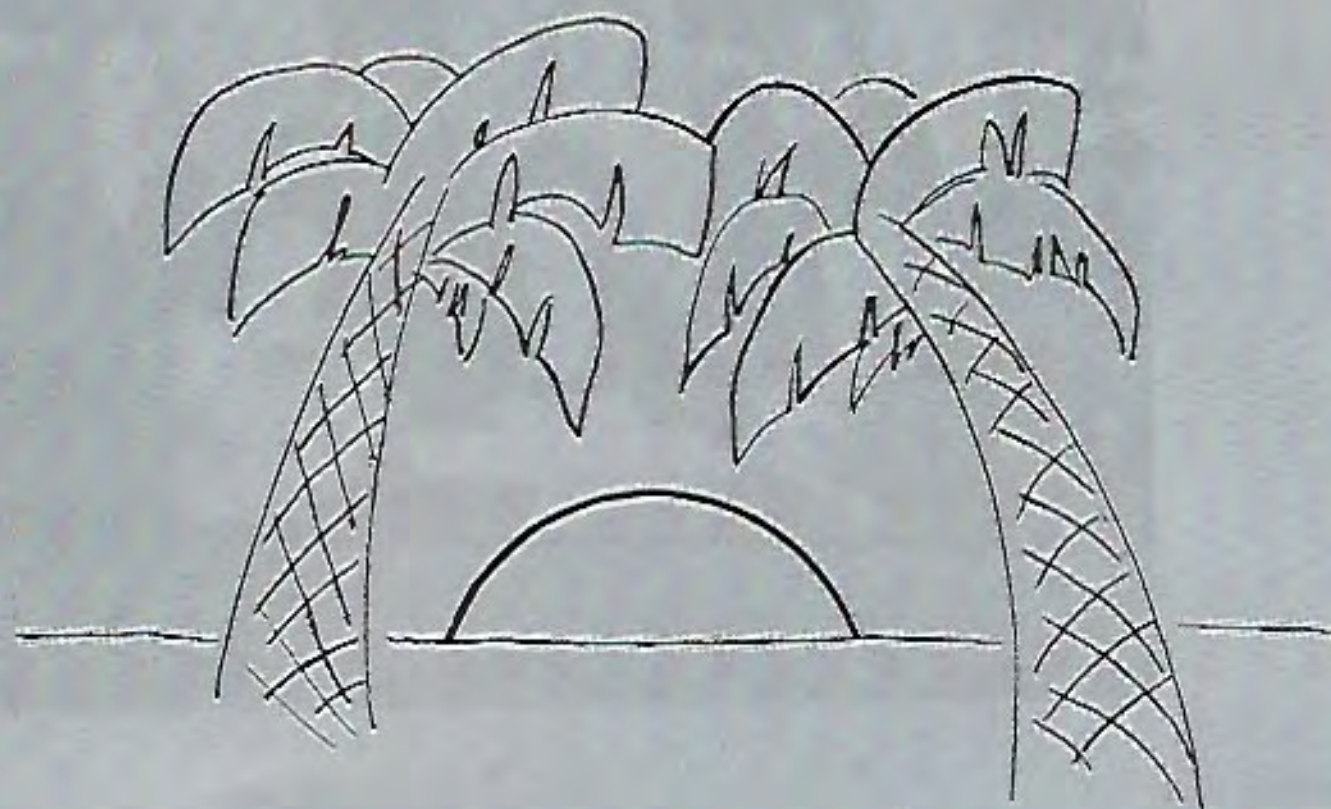

# STUDENT COUNCIL

## MEMBERS:

Mrs. Barbara Cagley: Advisor  
(Council Picture: L to R)

Front:

Carrie Fletcher: Vice-President

Susan Turner: President

Nancy Quackenbush: Secretary

Back:

Irene Garcia: Parliamentarian

Virginia Macias: L.D. Captain

Sara Goehring: U.D. Captain

Vanessa Murry: Mascot

Tina Davis: Treasurer

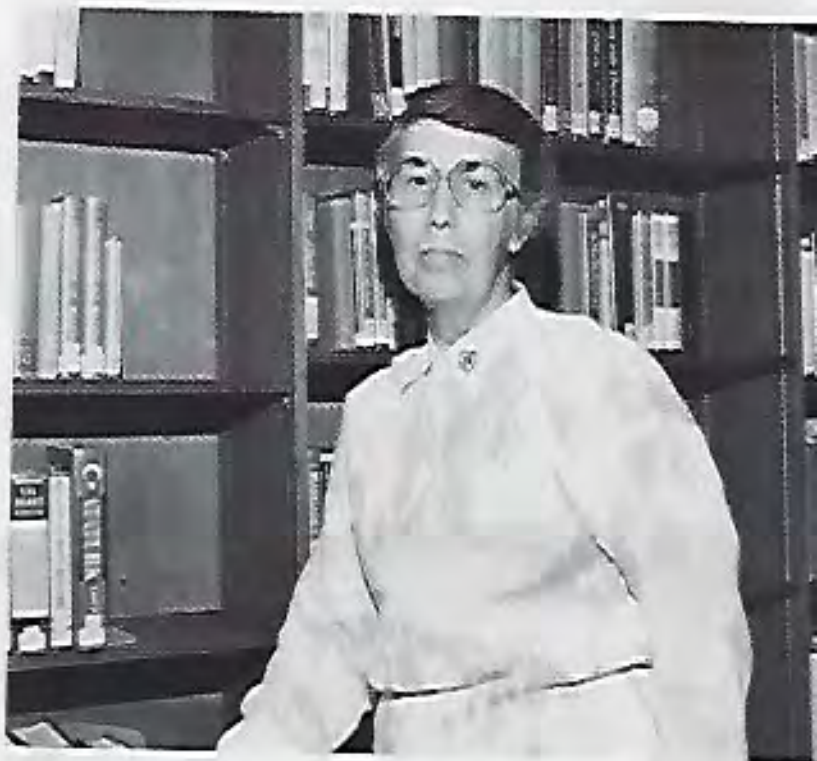



# CSF



Front Row: (Left to Right) Nancy Quackenbush, Meg Wolfe, Maya Christensen, Theresa Tran, Cecile Tran. Row 2: Teri Von Phul, Courtney Smith, Rosalie Santander, Valerie Febre, Row 3: Laura Goodrich, Lillian Fua, Erinn Lopez, Amy Silan, Ana Rios. Row 4: Lorraine Taylor, Carolyn Silan, Ana-Rhea DeGuzman, Martina Valdez, Back Row: Julie Cubanski, Anne Trinca, Eileen Cubanski, Cindy Giordano. Not Pictured: Lisa Neves, Laurie Perry, Christine Porter, Marcela Garcia, Melissa Mayorga, Richelle Deremo, Tina Davis.

Join CSF/NHS, the California Scholarship Federation and the National Honor Society. These two organizations give special recognition to those students who excel academically. If you want to go to college and get a scholarship, this is the club for you. Criteria for selection of each club is based on leadership, service, and scholastic achievement. To be a member of either club, you need to achieve a 3.0 grade point average. All students are eligible to apply. The advisor for these clubs during the 1985-86 school year was Mrs. Cassetta. Both of the groups' main goal is to tutor students who need extra help.







Front Row: (Left to Right) Teri Von Phul, Nancy Quackenbush, Valerie Febre, Meg Wolfe, Maya Christensen, Theresa Tran. Row 2: Ana Rios, Amy Silan, Lillian Fua, Laura Goodrich, Erinn Lopez, Ana-Rhea DeGuzman, Carolyn Silan. Back Row: Lorraine Taylor, Sharon Castillo, Anne Trinca, Cindy Giordano, Julie Cubanski, Eileen Cubanski. Not Pictured: Tina Davis, Lisa DeBlasio, Richelle Deromo, Sonia Hernandez, Melissa Mayorga, Tina Valente. CSF/NHS Advisor: Mrs. Chrys Cassetta





The Spanish Honor Society: Top Row: Christa Conrado, Mrs. Bachelor, Tammy Lovato, Lisa Mejia, Laura Goodrich, Becky Corona, Mary Aguilar. Bottom Row: Sheree Page, Marcela Cathcart, Beatriz Avalos, Melissa Gallegos, and JoAnn Baluyut.



# MAYA CLUB



Top Row: Angie Rodriguez, Deanne Cervantes, Melissa Hagemann, Martha Garcia, Maria Ramirez, Kathy Martinez, Lorena Castellanos, Diana Yanez, Veronica Perez, Tammy Lovato, Xochitl Hernandez, Sophia Romo, Karina Basurto, Renee Rodriguez, Middle Row: Deanna Abeyta, Sandra Wong, Tracy Martinez, Maria Requejo, Juanita Ortiz, Irene Garcia, Becky Lopez, Cecilia Sanchez, Lisa Torres, Elizabeth Ramirez, Yolanda Perez, Veronica Hernandez, Maria Pires, Lisa Saucedo, Dena Cervantes, Regina Dias, Tillie Aguilera, Yolanda Ramirez, Stephanie Martinez, Vanessa DeLeon, Rebecca Fielder, Tiffany Solorio, Becky Madrigal, Leslie Whitlow, Yvonne Garcia.



Advisor: Sister Maria Campos  
President: Angie Rodriguez  
Vice-President: Xochi Hernandez  
Secretary: Yvonne Garcia  
Treasurer: Yvonne Garcia  
Parliamentarian: Renee Rodriguez

# HOLLYWOOD'S HOT NUMBERS

*Mathletes Theorem: Spirit + Fun + Application of Math Skills + an Infinite Desire for Math = Success, if and only if, 4 Sophomores + 4 Juniors + 3 Seniors = Mathletes.*

Mathletes is an academic team made up of spirited, fun-loving, persevering students who have a talent for solving numerical problems. The members of the Mathletes are the following: Jo Ann Baluyut, Maya Christensen, Julie Cubanski, Valerie Febre, Lillian Fua, Sara Goehring, Mai Luong, Louisa Renteria, Amy Silan, Ann Trinca, and Meg Wolfe. The Mathletes meet and compete with other students at different schools each month. They are given two math problems from arithmetic, Algebra I, geometry, Algebra II, and Trigonometry Analysis to solve in ten minutes. Using common sense and much thought, they try to figure the answer. When they find out that their answer is wrong or cannot get an answer, it is all right. They pick up their spirits and try again. Mathletes is not all suffering and hard work; there is fun at the meetings. The school sponsoring the meet at that month provides ample snacks.

Sara Goehring said, "We've all gained three pounds from all those cookies!" One can meet new and old friends, too. Anne Trinca asked, "Are there any fine guys in Mathletes?" "Yes, Anne, but they are few and far between," replied Sara Goehring. If you are in doubt about joining the Mathletes next year, remember Hollywood's hot numbers, and become one of them!



Back Row from left to right: Jo Ann Baluyut, Meg Wolfe, Sara Goehring, Julie Cubanski, Mrs. Pro. Front Row: Anne Trinca, Lillian Fua, Amy Silan.

# I HAVE A DREAM



Marking a memorable day in history, Martin Luther King, Jr.'s birthday was honored by the Eboné Club on January 17. Led by Mistress of Ceremonies, Michelle Fanner, the spirited club presented a fascinating show of vocal and dancing talents during the annual Martin Luther King, Jr. Assembly. Entertaining festivities included our own Yvonne Jennings, a gifted soloist who beautifully sang "The Greatest Gift of All" and sophomore Kellie Curtis, who strutted her stuff to the sound of "Tour de France"! An exceptional recitation of James Weldon Johnson's "The Creation" was given by Erika Rawlins. Joining in the celebration, Mona Finner, a sophomore from Valley High School, had a voice so powerful and emotional that she brought the audience to their feet for a standing ovation — twice! Towards the end of the assembly, Sister Bridget surprised the students with her rendition of excerpts from Martin Luther King, Jr.'s "I Have a Dream." Concluding the assembly, the audience was encouraged to join the Eboné Club in singing "Reach Out and Touch Somebody's Hand", thus allowing all to experience a part of their heritage.



Front Row from left to right: Michelle Fanner, Margaret Locke, Yvonne Jennings, Daneen Wicks, Robyn Brown, Leslie Whitlow, Rebecca Fielder. Second Row: Sr. Michelle, Christy Davis, Kellie Curtis, Sheelah Becknell, Erika Rawlins, Darla Weaver. Third Row: Allenette Peterson, Marian Stovall, Monique Kenoly, Kenna Hamilton, Dina Sequeira. President: Daneen Wicks; Vice-President: Vanessa Murray; Secretary: Robyn Brown; Treasurer: Yvonne Jennings.

# OUR NEWEST CELEBRITIES!



Miss Kette Bagley  
Anatomy and  
Physiology

Miss Patricia Donovan  
Mathematics

Mrs. K  
M



Cassandra Davis  
Grade 10

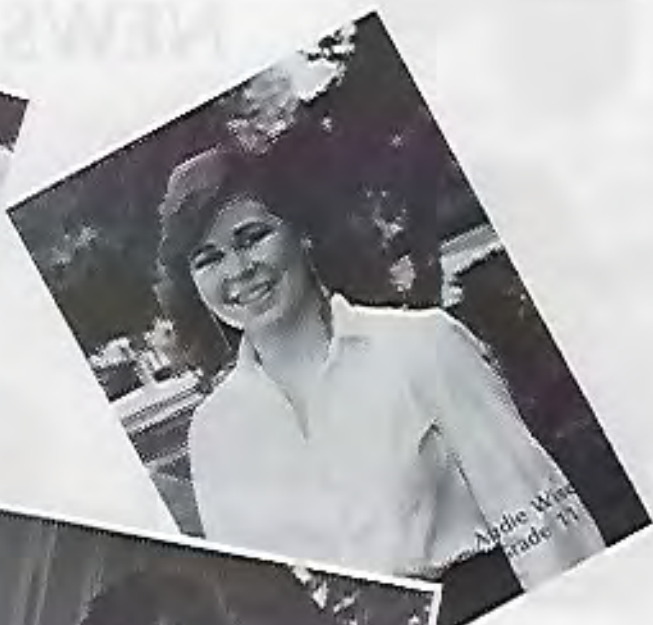

Abbie Winslow  
Grade 11



Mary Kwong  
Grade 11



Allison Garcia  
Grade 11



Bobbie  
Grade 11



Tess Warwick  
Grade 10



Kristen Sparre  
Grade 11

# NEWSPAPER







Extra! Extra! Read all about it! The Manogue Newspaper is a course which studies the basic principles of writing. The course helps students who are interested in journalism or publication. The Newspaper class not only deals with the *Epitaph*, but also with the Student Council Newsletter and the Manogue Messenger. Members of the newspaper staff include: Sister Nancy, Becky Corona, Jennifer Council, Yvonne Garcia, and Bertha Chavez. Newspaper is a lot of work, but it's also fun. Hard work and dedication paid off and made the newspaper a great success.



## REACH OUT! REACH OUT!



"Being in Social Action is a very special opportunity. It is an opportunity to give and receive. The giving we do in Social Action is usually just a warm smile or a cookie. It might even be an article of great need to somebody who has no home. The receiving is much more than anything materialistic. The feeling that comes over us when we get a smile back or a "Thank You" is overwhelming! Just knowing that our contribution can be of great help to someone in need is a special gift — the gift of Friendship.

- Becky Corona  
Co-President of  
Social Action

**MEMBERS**

Advisor: Mr. Matt Myres  
Co-president: Becky Corona  
Co-president: Lynly Gant  
Kathy Vessels  
Grace Goff  
Laura Goodrich  
Mary Aguilar  
Heidi Pineda  
Kenna Hamilton  
Melissa Gallegos  
Beatrice Avalos  
Stacie Bolden

## AND TOUCH SOMEONE.



# DRILL TEAM: YOU LOOK M-A-H-V-E-L-O-U-S

## STARRING:

President: Carrie Fletcher

Vice-President: Omeedeh Minoui

Secretary: Yolanda Sanchez

Treasurer: Susan Turner

Historian: Sara Goehring

Dress Committee Chairperson: Ana Martin

Financial Secretary: Nancy Quackenbush

Senior Representatives: Suzy Delisle, Michelle Castillo

Junior Representatives: Angela Rice, Angie Rodriguez

Sophomore Representatives: Marcie Haro, Cindy Jasso

Freshmen Representatives: Suzy Gibson, Tracy Soto

DIRECTOR: Mrs. Lois Curtis

ASSISTANT DIRECTORS: Miss Ann Mandalla, Miss Socorro Romo

## PERFORMANCES AND PROJECTS:

Half-time at C.B. football games.

C.B. basketball team.

Weinstocks Santa Parade.

Portuguese Parade.

St. Patrick's Day Parade.

Sacramento Spirit Clinic.

Senior Citizens Handicaps.

Special Olympics.

Various Parish Festivals.

## SPECIAL AWARDS AT U.C. SANTA CRUZ:

"Superior" Trophy.

"Excellent" Pennant.

100 + ribbons.

Nancy Quackenbush: 2nd Place Medal in drill down of over 500 girls.

Carrie Fletcher: Finalist in the "Miss Super Sensational" Contest.





# OUT OF CHAOS.

## MEET THE CAST!

Kim Harris	Co-Editor
Laura Goodrich	Co-Editor
Monet Trevino	Layout Editor
Valerie Febre	Layout Editor
Tracy Yates	Copy Editor
Lillian Fua	Copy Editor
Rachel Lewis	Photo Editor
Maya Christensen	Photo Editor
Marie Oropeza	Business Manager
Martina Valdez	Business Manager

## CO-STARRING

Rachel Lopez  
Melissa Martinez  
Becky Hershberger  
Ana Rhea de Guzman  
Elizabeth Janson  
Tammy Perez  
Lisa Styler

## FADE IN ...

Frantic Haste! Nervous Breakdowns!  
Pulling Hair and teeth etc. ...

Yearbook, believe it or not, is an actual class. In this class students learn patience, understanding, photography, and most of all how to cooperate with each other. While tensions are often high, the class is an experience which will help the students deal with difficult situations throughout life.

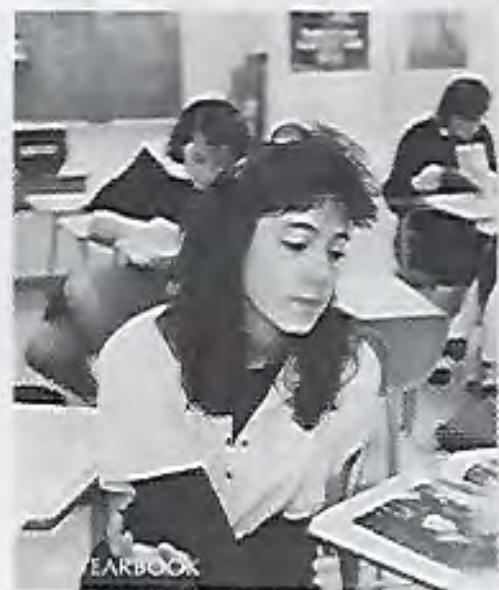

# ... A YEARBOOK

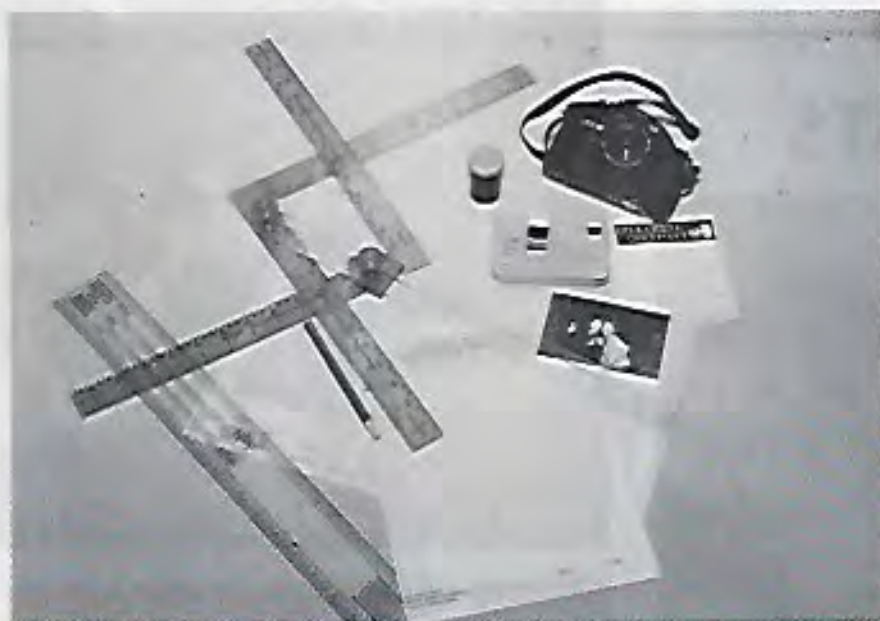

# LITURGIES AND RETREATS







#### A SONG OF PRAISE

I have waited, waited for the Lord,  
And he listened to me and heard  
my cry.  
He pulled me out of a dangerous  
pit,  
Out of the deadly quicksand.  
He set me safely on a rock  
And made me secure.  
He taught me to sing a new song,  
A song of praise to our God.  
SO I WILL SING A NEW SONG TO  
THE LORD.  
He does not want sacrifices or  
offerings  
But ears open to hear him.  
AND I WILL SING A NEW SONG  
TO THE LORD.

(Psalm 40)



# HOMECOMING WEEK



**NOT JUST FOR  
A WEEK, BUT...**



# HOMECOMING DANCE



... ALWAYS  
AND  
FOREVER



# HOMECOMING



**SENIOR PRINCESS**  
Karen Gums and escort Kelly Tiller



**JUNIOR PRINCESS**  
Jennifer Council and escort Tony Esola



**HOMECOMING QUEEN 1985**  
Susan Turner and escort Michael DeCuir



**SOPHOMORE PRINCESS**  
Karina Basurto and escort Michael  
Abila



**FRESHMAN PRINCESS**  
Lulu Benitez and escort Eddie Trujillo

# ROYALTY 1985



## HOMECOMING ROYALTY 1985

couples from left to right: Senior Prince and Princess: Nick Tobia and Karen Gums

Sophomore Prince and Princess: Peter Aros and Karina Basurto

Junior Prince and Princess: Jason Knowles and Jennifer Council

Freshman Prince and Princess: Mark DeVere White and Lulu Benitez

Homecoming King and Queen: Eric Berumen and Susan Turner

# "THE BEST OF TIMES"





On October 17, 1985, excitement mounted as the Juniors entered the library to receive their class rings that would symbolize their "Best of Times" at Bishop Manogue High School. Father Ed Lewis celebrated that special moment at 7:30 that evening with the class of '87 and their families and close friends. After the ceremony, refreshments were served and all gathered to congratulate and wish them success. Following tradition, rings were turned to the year of graduation and 87 is their goal. Indeed, these are

"THE BEST OF TIMES"!!!!!!



## ON A MISSION.

Campus Ministry at Bishop Manogue is as difficult to describe as the reason why caterpillars are moved to become butterflies. The ministry of bringing Christ to our fellow students seems to "just happen." Oh, sure! We have activities: retreats, student body and weekly liturgies, as well as community evenings are all part of our Campus Ministry program. But the joy and mystery involved in the spiritual growth of the Manogue community just happens naturally. Campus Ministry at Bishop Manogue High School recognizes the unique nature of each person's way of being spiritual. We encourage personal awareness and growth in the spiritual life of the individual. Campus Ministry works to facilitate a greater understanding of ourselves as we reach out to others in our school community. We provide opportunities for other youth to grow through retreats, community evenings, student and family liturgies and a greater awareness of others and God as we discover ourselves.





# FROM GOD!



Left to right: Front Row: Rayann Von Schoech, Lori Mamola, Lisa Saucedo. Second Row: Marie Oropeza, Susan Turner, Omeedeh Minoui. Third Row: Louisa Renteria, Marisela Haro, Michelle Castillo, Mr. Steve Jackson. Back Row: Marcela Cathcart, Hilary Rogness, Debbie Weber, Jackie Johnson, Elizabeth Janson, and Dolores Mermejo.

DISCOVER THE "U"  
IN "US"



It's 8:33 p.m. on a Thursday night some time during the school year. You're in your room, diligently cramming for the eight chapter history test you have the next day at 3rd period. Your hair is matted and twisted and you have just bitten off your last fingernail which has taken you three months to grow. All of a sudden — rrrin You think to yourself, "What a perfect excuse for a bre—" as you trip over your baby brother's Leggo tower, dashing madly to get to the phone. It's Brett Lundgren, the absolutely awesomest dude of your dreams — 50% jock, 50% brain, and 200% fine! He's just asked you to the Level tomorrow night and you've just accepted. You say good-bye. You are now going to faint, but no! You can't faint until you find something to wear! You open your closet and to your amazement your Espirit wardrobe has just disappeared! Your clmkothes clothes no longer exist: you're going to have to go to the dance in your uniform! No way! You run into the bathroom to wash away your tears. Then you look into the mirror. To your horror you have found a red, juicy zit on the tip of your nose! It's growing larger every second! You are having a nervous breakdown! Your broken body crawls on hand and knee into your bedroom. You're going to flunk your history test, which means that your parents probably won't let you go to the Level with Brett tomorrow night. But that's OK, considering you would have looked like a total geek in your uniform, anyway. That gruesome zit on your nose is still growing and you're now beginning to wonder if it's malignant. You are thoroughly depressed. You walk over to you General Electric Model 7-4630A Clock Radio and turn it on to your favorite station. You lie on you bed, pondering and listening — "The United Network presents an attempt to adjust your consciousness in a stimulating audio experience." Snore, ZZZZ, sleep. I don't know about you, but I feel a dream coming on.

It's sevenish on a Friday evening and you're listening to ABC's "Millionaire" in your custom built, custom decorated, and mega-buck New York Penthouse on 5th Avenue. Suddenly there's a knock at the door. You casually saunter over and open it. Behold! There stands Dolph Lundgren! (not his jiffy twin brother)

This is good stuff! You say, "Dolphy darling, it's you!" as you invite him into your 600,00 dollar penthouse. You two go out in his read Lamborghini and dine at "Tavern on the Green," where you feast on fillet mignon and drink Perrier. Suddenly he looks lovingly into your eyes and says, "Would you like to go for a ride in my model 12,000 speed boat?" You, expecting him to say something else are a little disappointed, but say you'll go anyway. Once on the boat, he tells you his driver isn't there so you'll have to be content with sitting in the harbor. The words lust, passion, and intrigue flash through your mind. Suddenly, he looks lovingly into your eyes (Do you see a pattern developing here?) and pulls out a pole and

starts fishing! The nerve! To fish on a date! What a geek. You, in a fit of rage, dropkick him off the deck into the water. As he pulls himself out of the water, you realize this guy is majorly buff! What a bo Before you can stop yourself, you blurt out, "Dolphy darling, flex for me! Pleas For me!" He, being the totally fine, arrogant, egotistical person he is, (don't take it personally, Dolph), agrees with a charming smile. Then he flexes and your heart stops and you die! What a wonderful way to die, huh?

Waking from your slumber, you begin to wonder, "Can I really grow up and have a life like that? What is my life like now? Who am I?" Well, here at Manogue, there are many different types of people who are unique and always will be. But who are you? Are you the person who stays up until 2:00 a.m. studying for a test in hisot history that the teacher decides to cancel? Are you the person who goes out of your way to violate every rule in the student band book? Are you the person who lives for pizza and ham burger days in the cafeteria? Are you the person who can become anything you want: a Fame dancer, a famous actor or musician, a tycoon, a housewife, a skid row bum etc. Whatever you choose to become, one thing is certain — you are "U"nique and "S"pecial. And WE ARE MANOGUE!

By Erinn Lopez and Laura Goodric



# THE GENUINE GAA



## GAA MEMBERS:

(Left to Right)

Top Row: Anita Garcia, Rayann Von Schoeen, Laura Schield, Amy Silan, Cathy Butler, Anne Trinca, Marlene Contreras, Jennifer Beno, Sandra Moreno, Deanne Cervantes, Lisa Trn, Eve Azeltine, Cindy Jasso. Row 2: Rosanne Aguirre, Sydney Harleaux, Roxanne Munoz, Stephanie McKenzie, Amy Schneider, Cathy Carda, Karin Ceaglio, Jenny Alberts, Jeanette Peterson, Abygail Medina, Regina Sams, Row 3: Vanessa DeLeon, Dawn Goff, Kerith Starkos, Kellie Curtis, Leslie Whitlow, Rebecca Fielder, Teri Von Phul, Ana-Rhea De Guzman, Bertha Chavez, Laura Goodrich, Cindy Davis, Samira Nassar, Lorna Butts, Jenny Vine. Row 4: Becky Hershberger, Beatriz Avalos, Laura Fernandes, Minka Weaver, Charlene Cheung, Jennine Tran, Jana Morris, Joanie Davis, Mary Moore, Lisa Lippincott, Karina Basurto, Nichelle Moreno, Christa Conrado. Row 5: Miss Sharon Luck (Advisor), Haydee Pineda, Alicia Chavez, Cindy Giordano, Meg Wolfe, Sheri Castillo, Julie Cubanski, Eileen Cubanski, Wendy Semon, Christine Wilfong, Sundae Brooks, Pam Fratis, Pam Johnson, Gabbie Cammarano, Lucille Moreno. Front Row: Louisa Renteria, Tina Davis, Michelle Castillo, Carolyn Silan, Debbie Weber, Lori Mamola, Ruth Planchard, Stacie Hansen, Debbie Garcia, Colleen Parise, Janice Busch, Elena Biundo, Pam Gesdahl, Deann Cervantes, Celeste Elder.



# PERRY MASON RETURNS!



Top Row from left to right: Tere von Phul (Defense Attorney), Michele Farmer (A.), and Dorene Rodriguez (Defense Attorney). Mrs. Blubaugh (Teacher Coach), Evelyn Silan (Prosecution Witness), Jean Vinson (D.A.), Sharmie Silva (D.A.), and Orispeza (P.A.). Renee Rodriguez (P.W.), Robyn Brown (Defense Witness). Third Row: Lorraine Taylor (D.W.), Tracy Ward (P.W.), Onedrah Minouli (D.A.), Sharon Rodriguez (P.W.)

## MOCK TRIAL OF '86

By Sharmie Silva

This year's mock trial team was one of the best ever at Manogue. We all worked really hard, learning in a few months what normally would take a year to learn. We "did our best, which was the best," as Mrs. Blubaugh commented.

The case we had this year was about a girl, played by Tere von Phul, who was accused of computer crimes and vandalism.

We "went up" against Kennedy for a practice round, on January 15, 1986, in which both schools did an excellent job. Our first round for points was against St. Francis. They proved to be quite a challenge; however, we won that first round. The second round, against Grant, we lost. Later we were informed that the loss was due to a miscalculation of points. Our next round was against Encina, which we won, yet because one of the scoring judges for that round didn't turn in our scores, our overall score was lower than expected. Consequently, we didn't make it to the semi-finals — the reason probably being that we were missing that very important score sheet.

Kennedy's scores had also been miscalculated, but finally they convinced the judges to recalculate their scores. In doing so the judges discovered that Kennedy should have been in the semi-finals rather than McClatchy, McClatchy. They then decided to replace McClatchy with Kennedy.

Even though the judges were unable to calculate Manogue's scores again, we were very happy for Kennedy. We were more than satisfied that at least Kennedy got a fair deal! We then went and supported Kennedy in their semi-final round against Loretto. As crazy as it seems, we were all felt a sense of duty and pride in supporting Kennedy. Since both of our teams had been through the same ordeal, we felt as if Kennedy was also representing Manogue in the semi-finals. We were behind Kennedy all the way!

Although Manogue's Mock Trial Team didn't make it to the semi-finals, it was still a very fulfilling opportunity to be a part of Manogue's Mock Trial Team of '86. Not only did we befriend a long time rival (Kennedy), but we also were fortunate to have the chance to work with Mrs. Blubaugh and Mr. Glenn Powell.

May the spirit of Manogue's Mock Trial Team continue to live on and thrive through the years! Hopefully next year the team will make it to the semi-finals.



## THE INTERNATIONAL FESTIVAL

AT LAST! All the planning, baking, raffling, and basically hard (but fun) work came together to put on the event of the year—the International Festival, where many nationalities came together to share traditions, customs, and cuisine, all for the benefit of Manogue's finances.

There were games, food, and live entertainment, which added up to a good time for all!

The food booths included Filipino, Mexican, Italian, Portuguese, and American. There were video games, a milk can toss, dart booth, and a biorhythm booth. For the entertainment, there were dancers and a DJ.

We all owe Norris Walery, the chairperson, and the co-chairpersons, John Trier and Mrs. King, a big thank you for all the work that they pitched in to help us raise a whopping net of over \$16,000!!!!!!



WELCOME  
TO THE  
International  
FESTIVAL



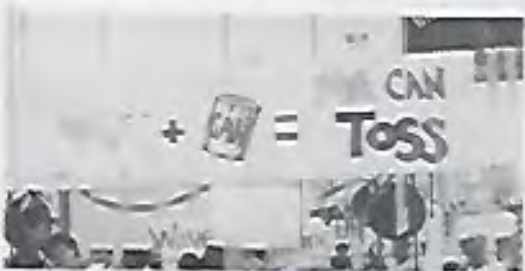
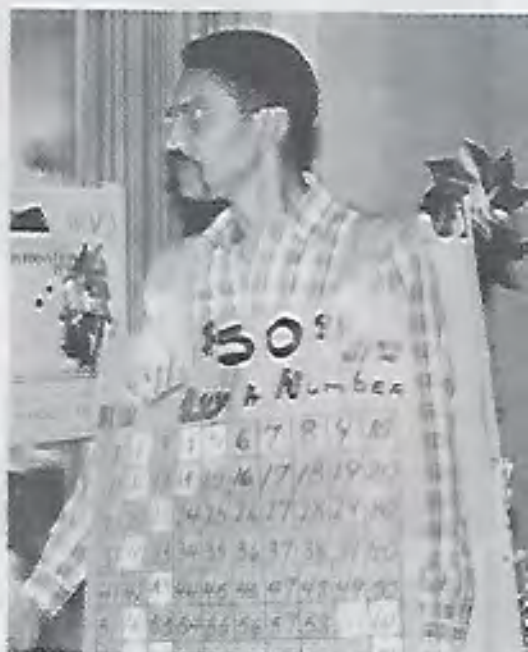



Front Row, L to R: Mr. Robert Roma, Sister Bridget Mary Flynn, Mrs. Lois Curtis, Mrs. Margaret Roma. Middle Row, L to R: Mr. Pedro Jasso, Miss Sharon Luck, Mrs. Bertha Bejarano, Ms. Caroline Nevarez. Back Row, L to R: Mr. Russ Korhonen, Mr. Frank Vega, Mr. Ray Turner, Mrs. Vicky Turner, Mrs. Lynda Gibson, Mrs. Carmen Jauregui, Mrs. Rachel Contreras. (Not pictured: Mr. Sammy Espinoza, Mrs. Terry Espinoza.)

## BOOSTER CLUB 1985-1986

### OFFICERS

President:	Mr. Russ Korhonen
1st Vice-President:	Mr. Pedro Jasso
2nd Vice-President:	Mr. Frank Vega
Secretary:	Mrs. Rachel Contreras
Financial Secretary:	Ms. Caroline Nevarez
Treasurer:	Mr. Ray Turner
Historian:	Mrs. Carmen Jauregui





**Saint Robert School**  
2251 Irvin Way - 452-2111  
Sacramento, CA 95822



**BEST WISHES**  
from  
**IMMACULATE CONCEPTION PARISH**  
2549 32nd Street

Pastor: Rev. Daniel Madigan  
Associate Pastor: Joe Valloran  
Parish Secretary: Mary Church  
School Principal: John Healy  
CCD Director: Kim Healy

**DR. PRISCILA M. LINSAO**  
LADY DENTIST

SOUTHGATE PROFESSIONAL CENTER  
3811 FLORIN ROAD SUITE 24  
SACRAMENTO, CALIFORNIA 95823

TELEPHONE  
(916) 427-2233  
427-2234



**Teresita P. Fua, M.D.**  
Pediatrician

Southgate Medical Center  
3811 Florin Road, Suite 11  
Sacramento, CA 95823  
Phone # 393-9613

Office hours by appointment only.

**BEST WISHES FROM THE SISTERS OF  
MERCY OF AUBURN**

Sisters of Mercy  
535 Sacramento Street  
Auburn, California 95603

**CONGRATULATIONS**  
to the  
**CLASS**  
of  
**1986**

-From the parents of a former  
Bishop Manogue Graduate.



Dearest Jennifer,  
 You have always  
 been our star with  
 a beautiful smile!  
 We love you very  
 much and are very  
 proud of you! May  
 the light always  
 shine for you.  
 Love,  
 Dad, Julie  
 Mom, Jesse

JENNIFER VALDIVIA



To our oldest  
 and first gradu-  
 Wishing you  
 best of luck for  
 the future.  
 We love you  
 and always will  
 Mom and D

ANNA CHRISTENSEN



Lord, thank you  
 for this gift called  
 Susan Rose. Her  
 quick wit and  
 contagious laugh,  
 her willingness to  
 listen and to reach  
 out to others have  
 enriched many  
 lives—a gift of love.  
 Her family  
 thanks you.

SUSAN TURNER



Dear Melissa,  
 Feb. 20, 1964  
 day to remem-  
 A wonderful  
 daughter arriv-  
 to enrich our  
 Today our  
 young lady sta-  
 ready to seek  
 future. May she  
 know that she  
 supported,  
 applauded, and  
 very much lov-  
 Dad, Mom, and  
 Larry

MELISSA MARTINEZ



Dear Kim,  
 Thank you so  
 much for all the  
 pride, happiness,  
 and loving  
 companionship  
 that you've  
 brought to our  
 family. May God  
 continue to bless  
 you and provide  
 you with as much  
 happiness as you  
 are enjoying at  
 this time.  
 We love you  
 dearly,  
 Mom and Dad

KIM HARRIS



Stacie,  
 The rest is u-  
 you. You will  
 always have m-  
 love. You can  
 forth and mak-  
 both happy. I  
 cherish the ye-  
 we have toget-  
 Your Mother  
 Rosamond

STACIE BOLDEN



Courtney,  
 I treasure seeing  
 you grow into a  
 lovely young  
 woman, whom I  
 cherish as a  
 daughter, as well  
 as a friend. May  
 our relationship  
 grow and blossom  
 as you have. You  
 will always "light  
 up my life."  
 Mom

COURTNEY SMITH



Estimada Mari-  
 Le damos gr-  
 a Dios por hab-  
 darnos una hij-  
 como tu. Estan-  
 muy orgullosos  
 ti y sabemos q-  
 con la ayuda d-  
 Dios y tu  
 capacidad,  
 alcanzaras el  
 triunfo.  
 Con amor,  
 La Familia  
 Oropeza

MARIE J. OROPEZA



Dear Lisa,  
We thank you  
for the love and  
happiness you  
have given to us  
as a family. May  
all your dreams  
become a  
reality.  
Love you,  
Dad, Mom, & Joel

LISA DE BLASIO



Monica,  
Be all you can  
be and go for the  
highest heights.  
Love,  
The Gang:  
Mom, Dad, and  
your Brothers

MONICA WOOTEN



Tressy,  
You're a real  
treasure in our  
hearts. We love  
you and will  
always be there  
for you. God be  
with you always.  
Love always,  
Dad and Mom

TRESSY ESPINOZA



To our wonderful  
daughter, Claudia;  
May you achieve  
everything you  
strive for. Go with  
God's blessing and  
ours too.  
Love you,  
Mom, Dad,  
Lombardo,  
Margaret,  
Theresa, Alex

CLAUDIA ORTEGA



Congrats, Diane,  
As you reach  
this important  
milestone, we  
want you to know  
how much  
happiness you  
have added to our  
lives. You have  
grown into a fine  
young woman and  
we are very proud  
of your  
accomplishments.  
We wish you the  
very best in  
everything you do.  
We love you,  
Mom and Dad

DIANE DUNCANSON



Dearest Omeedeh,  
We are so proud  
of your  
accomplishments  
and love you  
dearly. May God  
bless you and help  
you attain your  
goals. Accept only  
the best-that's  
what you are!  
Love,  
Mom and  
Rameen

OMEDEH MINOUI



Kelli:  
It seems like just  
yesterday,  
We both were so  
young.  
Now we're  
growing older,  
With much left  
undone;  
I know you'll do  
well,  
But if ever you're  
scared  
Just call on me-  
You know I'll be  
there.  
I Love You,  
Mother

KELLI DEUSON



Susan,  
You have been the  
greatest sister  
that any kid  
brother could  
have. Whenever  
I was in need,  
you were always  
there. Thanks  
Susan, for having  
loved and cared  
for me so long.  
Love,  
Scott Ralph

SUSAN TURNER



Tina,  
You're a very special person with great hopes and desires. We want you to know that you can count on our love, prayers, and support.

Love, Mom, Dad, Julie, Chris, Mike, and Cindy

TINA DAVIS



Karen,  
You are a joy. We hope you follow your dreams, conquer your fears, and accomplish your goals. We love you and we are proud of you. Keep up the good work!  
"Love from your family"

KAREN GUMS



Dear Carrie,  
With memories of all you've been ...  
With pride for all you are ...  
With hope for all you'll be ...  
And with love ... for always.  
Love,  
Mom

CARRIE FLETCHER



Dear Sara,  
We are so proud of you; we always have been and always will be. You are the light of our lives, and you have given us so much joy. In your words, "you are really a rad."  
Love,  
Mom and Dad

SARA GOHRING



Dear Debbie,  
Congratulations! Looks like you made it!  
Love,  
Mom

DEBBIE GARCIA



Maria,  
May the blessings of the Lord be with you wherever you go.  
Love,  
Your family

MARIA MONTANEZ



Dear Angela,  
Such a bundle of joy to us when you were a child. Now you are grown up and we love you so much. We are proud of all your achievements. We cherish your beautiful voice, beautiful smile, and beautiful heart. Proud to be your family: Dad, Mom, John Jr. and Denise.

ANGELA BUXIE



To Our Baby Girl,  
Hope your dreams are bright and true, and your future good to you. We know this is a special time for you and we just want to have the chance to say that we love you.  
Mom and Dad

MICHELE RAMIREZ



Dear Elena,  
I have loved and cared for you from the moment I first saw you in my arms. My wish for you is to grow and become all that God intended you to be. Let no one ever stop you from becoming you.

Love,  
Mom

ELENA BIUNDO



Lori dear,  
We thank God and praise him for the gift of YOU! You are so special. As you journey through life hand in hand with Jesus, may His light and love shine through you forever. We love you.

Mother and Dad

LORI MAMOLA



Dear Hillary,  
We love for who you are, have been in the past, and will be in the future. You have enriched us all and brought us continuous love and laughter. We are very proud of you.

Our never-ending love,  
Mom, Dad & Matthew

HILLARY ROGNESS



My Beloved Margaret:

If you can stop one heart from breaking, you shall not live in vain!

If you can ease one life the aching or cool one pain, or help one fainting robin unto his nest again, you shall not live in vain.

MARGARET LOCKE



Sylvia,  
We'll pray that all your hopes and dreams come true. Set your goals high; however, set them one at a time so that, if in the event that you fall one, you won't be totally disappointed.

Love,  
Mom and Dad

SYLVIA FRANCO



Janice,  
It has been a real pleasure watching you grow and mature over the years. May God continue to perfect that which He has begun in you. May you be all that He wants you to be.

LOVE-  
Mom and Dad

JANICE LEE BUSCH



Dear Kristine,  
You're a lovely and gifted young lady, a wonderful daughter. Sharing your hopes and dreams, watching you become all you can be brings happiness and pride to us. May all your dreams come true.

Love,  
Mom, Dad,  
Darin, Russ

KRISTINE HUDDY



Peanut,  
We are all very proud of you, Judy. You have made it through the ups and downs of your high school years.

We will stand behind you in whatever you do. We all love you and may our Lord keep you in "good health" and happiness.

Love Ya,  
Mom, Dad,  
Debra, Linda  
Victor Jr.

JUDY TALANI



Marcella:  
From birth, your  
growth and grace  
has given your  
family tender  
pride and joy. You  
have assets that  
few people have  
in our world:  
compassion and  
integrity. Develop  
them! Enrich your  
work; enrich  
yourself.

Love, Mom, Dad,  
Paul, Mary,  
Ellen, Olfelia, and  
Rosa

MARCELLA CATHCART



Dear Ruth:  
We have al  
been and wi  
ways be very p  
of you.

Love Al  
Mom and

RUTH PLANCHARD



Monet:  
You have filled our  
hearts with love  
and happiness. We  
are very proud of  
you. God is  
thanked everyday  
for giving us a  
daughter and sister  
so special.

All our love,  
Mom, Dad, David,  
and Lynette

DENA MONET TREVINO



Dear Debs:  
You have bro  
much to us fo  
ing the very sp  
person you  
May God bless  
throughout  
entire life.

Love, Mom,  
Paul, Bec &

DEBBIE WEBER



Querida hija,  
Te deseo lo mejor  
en el futuro. Ojala  
que sigas adelante  
siguiendo tus  
suenos. De parte  
de tu mama quien  
te apoya y siempre  
te quiere.

DORENE RODRIGUEZ

**THANK YOU TO OUR  
PATRONS**

MARTHA AND OSCAR CHRISTENSEN  
RUDY AND SUE SCHNEIDER

**CONGRATULATIONS**

CLASS OF 1986  
MRS. HAAN



ABIGAIL HAWKESWOOD  
SMILING FOR THE  
CLASS OF '86

# The Quality of Mercy

Mercy Hospital of Sacramento — serving the health care needs of Northern California's families.

- General acute hospital care
- Outpatient ancillary services including laboratory, nuclear medicine, radiology, physical therapy
- 24-hour emergency care
- Mercy Obstetrics Service
- Mercy Hospice Sacramento
- Mercy Cardiac Rehabilitation Program
- Pulmonary Reconditioning Program
- Mercy Family Meals — senior nutrition program



Mercy Hospital of Sacramento

4001 J Street  
Sacramento, CA 95819  
Telephone: 453-4545







The Virgin Sturgeon  
 Located on the Sacramento  
 River-  
 floating on a barge-  
 Come enjoy the sunsets-  
 Breakfast served on the  
 weekends-

Lunch- 11:30am to 2:30pm-  
 Dinner- 6:00pm to 11:00pm

### Mason Guest Home

209 N. School Street  
 Lodi, Ca. 95240  
 (209) 369-1131

Bino & Pet Pascual  
 Owner/Administrator



- Reasonable Rates
- Three Meals Daily
- 24-Hour Provision of Health & Medication
- Private & Semi-Private Rooms

## CONGRATULATIONS SENIORS!

St. Lawrence's Church  
 4325 Don Julio Blvd.  
 North Highlands, Ca. 95660



## CRYSTAL POOL SUPPLY

5500-24th street  
 corner of Fruitridge  
 Sacramento, Ca. 95822

4710 El Camino Ave.  
 1150 Fulton Ave.  
 Sacramento

## Congratulations Graduating Class of '86!

Best Wishes,  
 Holy Spirit Church, Sacramento.  
 Father Charles Brady, Pastor.



4524 Freeport Blvd  
 Sacramento, Ca. 95822

(916) 455-4921

### Garcia's Residential Care Home For The Elderly

15806 Maubert Ave.  
 San Leandro, Ca. 94587  
 Tels: 415-846-8070

Linda B. Garcia, RN  
 Administrator-

Amador L. Garcia  
 Owner/Manager



- 24-Hr RN Supervision
- Homelike Atmosphere
- Reasonable Rates
- Three Meals a Day
- Private & Semi-Private Rooms

# Coronet Portraits

2116 21st Street Sacramento, CA 95818 453-1116

YOUR OFFICIAL  
YEARBOOK PHOTOGRAPHER

WE OFFER COMPLETE  
PROGRAMS TO HANDLE . . .

- Senior Portraits
- Undergraduate Pictures & I.D. Cards
- Proms & Dances
- Sports Groups
- Senior Class Panoramic Photos

Specialists in School Photography

*Wavelength*

CATHOLIC MEDIA PRODUCTIONS

Kevin O'Brien

A Service of  
Youth & Young Adult Ministries, Diocese of Sacramento  
2519 L Street, Sacramento, CA 95816 (916) 446-4663

Portraits Architectural Commercial  
Fashion wedding

**Hamilton**  
**Photography**

1116 16th Street (916) 442-9033  
Sacramento, CA 95814 By Appointment Only





Sacramento's Finest Chauffeur Service  
Can Supply Classic Transportation for  
All Occasions...Business or Pleasure

ASK ABOUT OUR CLASSIC BUSES  
AND LIMOUSINES

**24 HR. SERVICE**

Champagne and Catering Available At Special Request

**452-7261**

**CAMP PENDOLA**  
operated by  
THE OFFICE OF YOUTH &  
YOUNG ADULT MINISTRIES  
WILDERNESS BACKPACKING  
girls session  
**JULY 6-JULY 19**  
for info, call:  
446-4664



ted econom  
georgin econom

**LAND PARK PHARMACY**  
- We Take The Time To Help

4404 del rio road sacramento, ca. 95822 telephone 916 452-2616

遠東樓

**FAR EAST CAFE**

Chinese and American Dishes  
5014 Freeport Blvd.  
Sacramento, California 95822  
(916) 456-9835

SAMMY LEONG  
Owner and Manager



# AUTOGRAPHS



THE UNIVERSITY OF CHICAGO PRESS  
530 N. DEARBORN AVENUE  
CHICAGO, ILL. 60610

1985-86

1985-86

1985-86

<p>1985-86</p> <p>1985-86</p>	<p>1985-86</p> <p>1985-86</p>
<p>1985-86</p> <p>1985-86</p>	<p>1985-86</p> <p>1985-86</p>



# SENIOR SIGNATURES

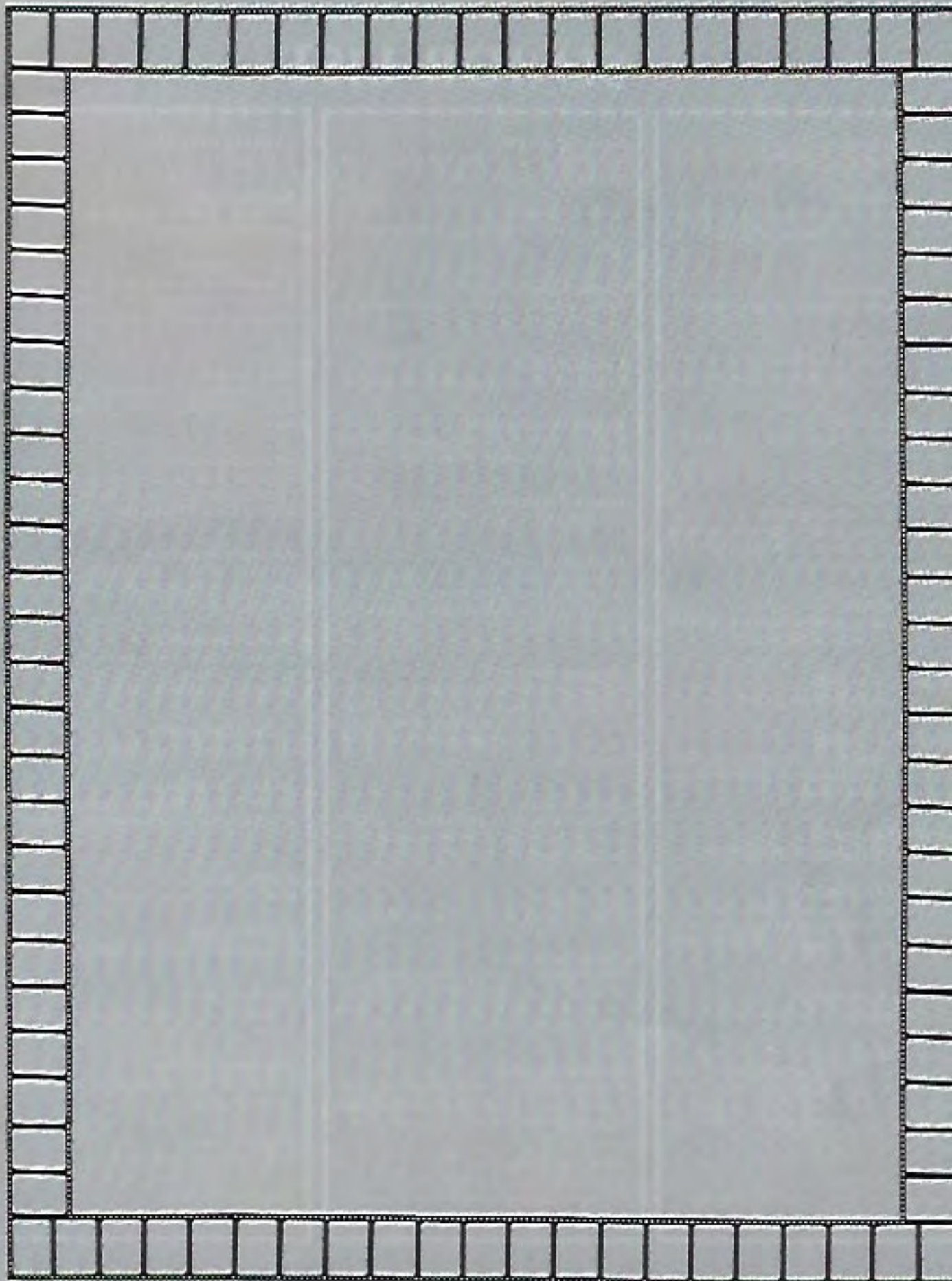

# SENIOR LIST

**Lisa Aguilera**

B Honor Roll-1.

**Martha Baeza**

B Honor Roll-2; Maya Club-1, 2, 3; Spanish Honor Society-1; Photography Club-1, 2, 3; GAA-3.

**Jo Ann Baluyut**

B Honor Roll-2; Spanish Honor Society-4.

**Flena Biundo**

A Honor Roll-1, 2, 3; B Honor Roll-4; NHS-2, 3; CSF-2, 3; Spanish Honor Society-2, 3.

**Stacie Bolden**

Drill Team-4; Ebone Club-2, 3; French Club-1.

**Janice Busch**

A Honor Roll-1; B Honor Roll-2, 3, 4; Volleyball-3, 4; Basketball-1; Class President-2; Class Representative-1; French Club-1, 2, 3; Spring Prom Princess-2.

**Angela Buxie**

A Honor Roll-2; B Honor Roll-1, 2, 3; NHS-2; CSF-2, 3; Junior Achievement-1.

**Heather Cardoza**

Swimming-4; Drill Team-2; GAA-1, 2, 3, 4.

**Michelle Castillo**

B Honor Roll-1, 2; Swimming-3; Drill Team-1, 2, 3, 4; Senator-4; Spanish Honor Society-4; Math Club-2, 3.

**Deann Cervantes**

B Honor Roll-1; Swimming-2; Soccer-3, 4.

**Anna Christensen**

A Honor Roll-2; Student Body Mascot-1; Senator-3; Photography Club Treasurer-3; Spanish Honor Society-2, 3; French Club-3; GAA-1, 2, 3.

**Tenisha Cummings**

C.B. Cheerleader-2, 3; Ebone Club-1, 2.

**Justina Davis**

A Honor Roll-1, 2, 3, 4; Volleyball-2, 3, 4; Soccer-4; Student Body Treasurer-4; Treasurer-3; NHS-2, 3, 4; CSF-2, 3; Spanish Honor Society-2; Math Club-2; GAA-1, 2, 3, 4.

**Naomi DeLeon**

Yearbook-3; Newspaper-3; Senator-3; Maya Club-1; TAA-1.

**Suzanne Delisle**

Swimming-1, 2, 3; Drill Team-1, 2, 3, 4; Senator-1, 4; Ebone Club-2.

**Kelli Deuson**

B Honor Roll-3; Soccer-2, 4; Photography Club-3.

**Diane Duncanson**

A Honor Roll-1, 3; CSF-2; Junior Achievement-2; GAA-2.

**Celeste Elder**

B Honor Roll-2; Volleyball-2; Soccer-3,4

**Jacqueline Escajeda**

A Honor Roll-2; B Honor Roll-1, 2; Drill Team-2, 3, 4; NHS-2; Maya Club-1, 2, 3.

**Tressy Espinoza**

B Honor Roll-1; Drill Team-1, 2, 3.

**Michele Fanner**

Perfect Attendance-1, 2, 3, 4; Treasurer-4; NHS-1, 2; CSF-1, 2; A Honor Roll-1, 2, 4; Ebone Club-2, 4; French Club-2; Mock Trial-3, 4; GAA-2, 3.

**Carolyn Fletcher**

A Honor Roll-1; B Honor Roll-1, 3, 4; Softball-2, 3; Drill Team-1, 2, 3, 4; Vice-President-2; CSF-1, 2, 3, 4; Spanish Honor Society-1, 2, 3; Student Body Vice-President-4; Spring Play-4.

**Sylvia Franco**

B Honor Roll-1, 2; Swimming-1, 2; Drill Team-4; Yearbook-2; Homecoming Princess-3; Maya Club-1, 2, 3, 4; GAA-1, 2, 3.

**Lynly Gant**

B Honor Roll-3, 4; Drill Team-4; NHS-3, 4.

**Debbie Garcia**

B Honor Roll-1; Tennis-1; Swimming-2, 4; Senator-1; C.B. Cheerleader-1, 2; Homecoming Princess-1; Drama Club-1; Maya Club-1; Ebone Club-2; Math Club-1.

**Pamela Gesdahl**

B Honor Roll-2, 4; Swimming-1, 2, 3, 4; Student Council-2; Class Mascot-2; Maya Club-4; Ebone Club-4; G.A.A.-1, 2, 3, 4.

**Sara Gochring**

B Honor Roll-1, 2, 3, 4; Drill Team-1, 2, 3, 4; UD Team Captain-4; Math Club President-3, 4; Historian-4.

**Cynthia Gonzales**

Yearbook-1.

**Karen Gums**

A Honor Roll-4; Basketball-1, 2; Team-4; Ebone Club-2, 3.

**Stacie Hansen**

B Honor Roll-3; Softball-2; Newspaper Manager Messenger-1; Ebone Club-1; Photography Club President-3; GAA-4.

**Kim Harris**

B Honor Roll-2, 3; Basketball-3; Yearbook-4; French Club-2; GAA-2, 3; Campus Library-4.

**Maria Hernandez**

B Honor Roll-1, 2, 3; Yearbook-3; Math Club-1; Spanish Honor Society-1; Math Club-1; GAA; Photography Club.

**Myrna Hernandez**

B Honor Roll-2; Basketball-2, 3; Math Club-1, 2, 3; Photography Club-1, 2; GAA-1, 2, 3.

**Sonia Hernandez**

A Honor Roll-1, 4; B Honor Roll-2, 3; NHS-1, 2, 3, 4; Maya Club-12; Spanish Honor Society-1, 2; Math Club-1, 2.

**Susie Hernandez**

Library Club-2; Maya Club-2, 3, 4.

**Jackie M. Johnson**

Soccer-1; Math Club Rep.-4; Science Club-1, 2, 3; GAA-1, 2, 3; Photography Club-1, 3.

**Karen Jones**

Drill Team-4; Ebone Club-2.

**Rachel King**

B Honor Roll-1, 2, 3, 4; Math Club-2.

**Rachel Lewis**

Yearbook-3, 4; Class Senator-1; School Play-4.

**Margaret Locke**

B Honor Roll-1; Basketball-1; Ebone Club Treasurer-1, 2.

**Rachel Lopez**

Yearbook-4; Maya Club-1, 2.

**Donna Lovejoy**

Swimming-1; GAA-1.



**Lori Mamola**

B Honor Roll-1, 2, 3, 4; Volleyball-1, 2, 3, 4; Basketball-3; Swimming-3; Yearbook-1; Mascot-3, 4; Block M-4; G.A.A.-1, 2, 3, 4; Activity Chairperson-3; Student of the Month-4.

**Ana Maria Martin**

B Honor Roll-1, 2, 3, 4; Drill Team-1, 2, 3, 4; NHS-4; CSF-4; Maya Club-1, 2, 3.

**Melissa Martinez**

A Honor Roll-1, 2, 3; B Honor Roll-1; Yearbook-4; Class Treasurer-1, 2; CSF-2, 3; French Club-2, 3; Camera Club-3, 4; GAA-1, 4.

**Margarita Mendoza**

Maya Club-2, 4

**Maria Montanez**

A Honor Roll-2; Class Parliamentarian-4; Maya Club-1, 2, 3, 4; Spanish Honor Society-2, 3.

**Omeedeh Minoui**

A Honor Roll-1, 2; B Honor Roll-3, 4; Drill Team-2, 3, 4; Vice President of Drill Team-4; Junior Achievement-2; French Club-1, 2, 3; Block M; GAA-1; Mock Trial-3, 4; Campus Ministry; Eucharistic Minister-4

**Lora Nebreda**

B Honor Roll-2, 4.

**Iechi Nguyen**

Volleyball-2; Math Club-2

**Maria Oropeza**

A Honor Roll-1, 2, 3; B Honor Roll-1, 2, 3, 4; Yearbook-4; Student Council-1; Senator-2; Sec-3; Class Secretary-2, 3; Class Representative-1; NHS-2, 3, 4; CSF-2; Spanish Honor Society-1, 2, 3; Math Club Secretary-2, 3; Mock Trial-2, 3, 4; Mathletes-2, 3; Homecoming Decorations Person; Social Studies Award-1; Biology Award-2.

**Claudia Ortega**

A Honor Roll-2, 3, 4; B Honor Roll-4; Drill Team-2, 3; Class Senator-2; NHS-3; CSF-2, 3, 4.

**Kimberly Palacios**

A Honor Roll-1; B Honor Roll-2, 3, 4; Tennis-1, 3; Softball-1, 2, 3; Soccer-4; Student Council-1, 2; C.B. CHEERLEADER-2

**Colleen Parise**

A Honor Roll-1; B Honor Roll-1, 2; Volleyball-1, 2, 3, 4; MVP-2; Swimming-2, 3, 4; GAA-1, 2, 3, 4

**Stephanie Pedone**

B Honor Roll-3; Softball-1, 3, 4; Drill Team-4.

**Renise Perez**

A Honor Roll-1; Basketball-1; Swimming

**Beth Pfister**

B Honor Roll-1, 2; Spanish Honor Society-2; Photography Club-3

**Ruth Planchard**

A Honor Roll-2, 3; B Honor Roll-4; Volleyball-2, 3; Basketball-1, 2, 3; Swimming-3, 4; Softball-2; Class Senator-2, 4; GAA-1, 2, 3, 4; Photography Club-2; MVP Swimming-3; MVP Softball-2

**Michele Ramirez**

Drill Team-4; GAA-1, 2; Photography-2

**Erika Rawlins**

A Honor Roll-1, 2, 3, 4; Ebony Club-1, 2, 4; French Club-1, 2; GAA-1, 2; Mock Trial-3, 4; School Play-1

**Louisa Rentiera**

Drill Team-2, 3, 4; Maya Club-2; Math Club-1, 3, 4; GAA-2, 3, 4;

**Dorene Rodrigues**

A Honor Roll-1, 2, 3; B Honor Roll-2, 3, 4; Track-2; Newspaper-3; Manogue Messenger-3; Student Council-2; Senator-3; Vice President-3; President-4; Class President-4; Class V, President-3; Class Representative-1; NHS-1, 2, 3, 4; Maya Club-1, 2, 3; French Club-1, 2, 3, 4; Mock Trial-2, 4; Spring Prom Queen-3; Director of Costumes & Props Spring Play-3; GAA-1, 2, 3; Uniform Committee-1.

**Hillary Rogness**

A Honor Roll-1; B Honor Roll-2; Drill Team-2, 3, 4; NHS-3; Math Club-2, 3; Moot Court-3; Gemco-4.

**Aida Rose**

B Honor Roll-1, 2, 3, 4; Photography Club-3

**Anna Rubalcaba**

B Honor Roll-1; Maya Club-1, 2, 3, 4; Spanish Honor Society-2; GAA-2; Photography Club-3.

**Yolanda Sanchez**

A Honor Roll-1, 2; Drill Team-2, 3, 4; Manogue Homecoming Princess-2; Maya Club-1, 2, 3, 4; Spanish Honor Society-2, 3.

**Mary Saalsaa**

Swimming-1, 2; Drill Team-1, 2, 3, GAA-1.

**Carolyn Silan**

A Honor Roll-1, 2; B Honor Roll-3, 4; Tennis-3; Soccer-2, 3, 4; Newspaper-4; Manogue Messenger-4; Class Secretary-4; Class Representative-3; S-2, 3, 4, CSF-2, 3, 4.

**Courtney Smith**

A Honor Roll-1, 2; B Honor Roll-3, 4; Drill Team-1, 2, 3, 4; Student Council-4; Senator-4; CSF-2, 3, 4.

**Keeley Thompkins**

B Honor Roll-1, 2; Basketball-1, 3; Softball-2; Ebony club-1, 2, 3; Spanish Honor Society-1, 2, 3; GAA-1, 2, 3.

**Monet Trevino**

B Honor Roll-2; Softball-2; Yearbook-2; Class Senator-1; GAA-1, 2, 3.

**Susan Turner**

A Honor Roll-1; B Honor Roll-2, 3; Swimming-3; Drill Team-1, 2, 3, 4; Senator-1, 2, 3, 4; Class President-3; Student Body President-4.

**Adina Velasquez**

B Honor Roll-1; Yearbook-1; GAA-1, 2.

**Jean Vinson**

A Honor Roll-1, 2; VOLLEYBALL-3; Swimming-1, 2; Student Council-3, 4; Class Representative-3; NHS-3; CSF-3.

**Julianne Walery**

B Honor Roll-1, 2; Swimming-3; Drill Team-4; N.H.S.-2; GAA-2, 3.

**Tracy Ward**

Volleyball-1; Track Team-2; School Play-2, 3, 4; GAA-1, 2, 3; Mock Trial Team-

**Daria Weaver**

B Honor Roll-1, 2; Basketball-2; Swimming-1, 2, 3, 4; Ebony Club-1, 2, 3, 4; Representative; Spanish Honor Society-2; Junior Princess Spring Prom; GAA-1, 2, 3, 4; Drama Fame

**Debbie Weber**

A Honor Roll-2, 4; Basketball-2, 4; Drill Team-2, 3.

# YEARBOOK II- A SEQUEL



Why are the people in this picture sporting such smiles? As you might remember, the yearbook staff (p. 108, 109) was originally comprised of seventeen dedicated students and one neophyte advisor. Since then, for various reasons, our competent staff has been reduced to a staff of four MORE-THAN-DEDICATED individuals. So a special and deserved thanks goes to *Sister Michellè*, our advisor, who had only about five cardiac arrests this year- one at each deadline; to *Monet Trevino* who was so neat that she didn't use a single drop of Boo Boo Goo the entire year; to *Molly Lipelt*, our critical analyst, whose creativity never ceased to amaze us from the time she joined the staff at the second semester; and last but not least, to *Lisa Styler*, who was responsible for naming people in large clubs (such as GAA), and who now knows every single person in this entire school by first, middle, and last name! (As editor, I also dedicated a few hours to the production of this yearbook.) So, as they say in the movies, this is "THE END". Have a wild and crazy summer.

Laura Goodrich/Editor

*Laura Goodrich*



# ESPERADE

SUPPLEMENT 1986





F  
A  
M  
E



# SPORTS SPECTACULAR



SWIM TEAM: Left to Right: Back Row: Pam Fratts, Heather Cardozo, Mickey Castellano; Coach, Todd Athey; Jennifer Albert, K. Ceaglio, Pam Gosdahl. Middle Row: Eileen Cubanski, Cindy Davis, Debbie Weber, Lori Mamiola, Colleen Parise. Front Row: Garrett, Michelle Castillo, Becky Hershberger, Jennifer Sontag.



SOCCEK: Left to Right: Back Row: Celeste Elder, Cathy Butler, Dena Cervantes, Christa Conrado, Anne Lima; Coach, Paul Aurelianos. Front Row: Carolyn Silao, Amy Schneider, Cathy Carda, Stephanie McKenzie, Tana Davis, Meg Wolfe, Amy Silao.



VARSITY SOFTBALL TEAM: Left to Right: Back Row: Coach, Jeanette Peterson, Christine Wilfong, Dawn Goff, Leslie Whitlow; Front Row: Rayann Von Schoech, Stephanie Pedone, Karina Basurto, Becky Vega, Mary Moore.



JR. VARSITY SOFTBALL TEAM: Left to Right: Back Row: Coach, Matt Myres, Monica Kelly, Korith Starks, Jennifer Beno, Kellie Curtis. Front Row: Nichelle Ramos, Regina Diaz, Valencia Hale, Theresa Perez.

# IN THE SPOTLIGHT

Right: Waiting ever so patiently in the picture line, Julie Valencia and Ricky Rodriguez wonder if they'll get their pictures taken before the night is over.

Below: Queen, Laura Goodrich, and her escort, Saul Garcia, flaunt that 'touch of elegance' during the royalty dance.



Spring Prom Royalty: From left to right: Last row: Escort, Oscar Munoz and Sophomore Princess, Veronica Perez; Sophomore Princess, Mariela Haro and escort, Danny Ibarra; Second Row: Escort: Victor Minnifield and Junior Princess, Danyela Wido; Junior Princess, Dolores Mermejo and escort, Andrew Varga. Front Row: Queen, Laura Goodrich and escort, Saul Garcia.



Above: Juniors, Becky Corra and Joni Lara, coyly chat with their escorts.





Left: Tresa Archuleta and her escort, Roger Tafoya take a moment to relax.

Below: Acting seductive, Christine McRae captures Mike Willis' undivided attention.



Lights, camera, action! All of the essential elements of a spectacular night made Spring Prom '86 a truly Hollywood affair. Colors galore and the D.J. Rick Delgado added to the grandness of this festive occasion. Still, the never-ending picture line left much to be desired. Nevertheless, it was an all-round gala occasion and no matter who your date was-Prince Charming or the Frog-this night brought all the stars out to shine.

Left: Unwinding from a hectic week of school, Suzanne McKelvey screams with sheer enthusiasm.

## SPRING PROM '86 A TOUCH OF ELEGANCE

# MASQUERADE BALL

FIREHOUSE, OLD SACRAMENTO, MAY 3, 1986

W  
H  
A  
T  
E  
V  
E  
R

W  
E  
I  
M  
A  
G  
I  
N  
E





## ROYALTY 1986

Left to Right:

Princess: Diane Duncanson

Princess: Courtney Smith

Queen: Tina Davis

Princess: Tracey Ward



# GRADUATION: END AND BEGINNING



# BEHIND THE SCENES!



# MINI OLYMPICS DAY



